

Operating instructions

Screw pump

Translation of the original operating instructions

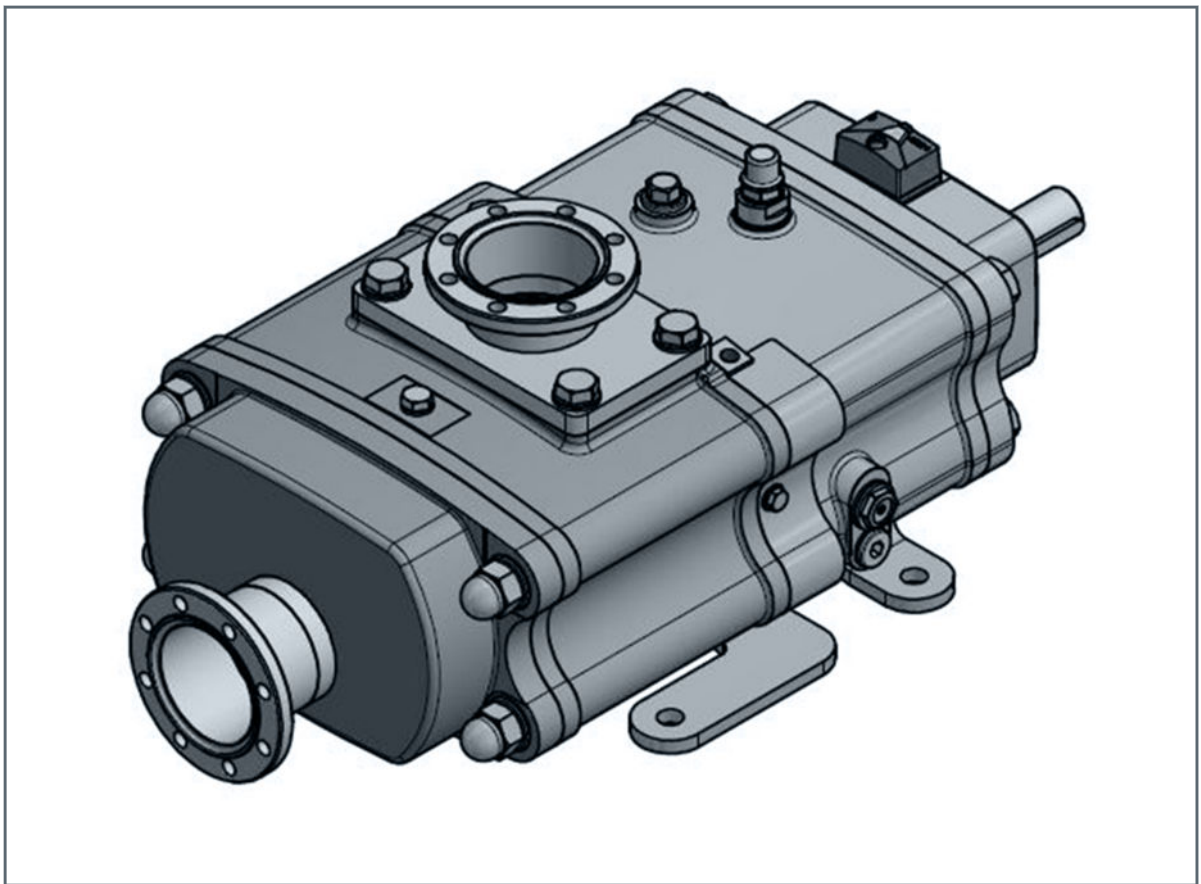

Type: SLH-5G

Hygiene application | non-Ex

 **Bornemann**

— An ITT Brand

Industriestr. 2 | 31683 Obernkirchen (Germany)
Telephone: +49-5724-390-0 | Fax: +49-5724-390-290
Email: info.bornemann@itt.com | Internet: www.bornemann.com

Type: SLH-5G
Hygiene application | non-Ex

Author: KME
Checker: BS/ML
22.09.2021 Rev.2, en_GB

© ITT Bornemann GmbH 2021

General information



This section contains some advance general information on using this manual, as well as the warranty conditions and the contact data for customer service.

About this manual

This manual enables safe and efficient handling of the pump. The manual is an integral part of the pump and must be kept in the immediate vicinity of the pump, accessible to personnel at all times.

The personnel must have carefully read and understood this manual before starting any work. A basic requirement for safe working is the adherence to all safety and handling instructions in this manual. Furthermore, local accident prevention regulations and general safety regulations apply to the area of application of the pump.

Illustrations in this manual are for general understanding and may differ from the actual combination.

Supplementary documents

In addition to this manual, you are receiving supplementary documents. These documents are part of the technical documentation of the pump and familiarity with them is absolutely necessary for the safe operation of the pump. The documents with the necessary information are listed in the following table.

Tab. 1: Supplementary documents

Document	Content
Data sheet	Technical data and operating conditions, output and operating limits
Dimensional drawing	Dimensions, weight, and connections
Supplementary document on lubricants and preservatives	List of suitable lubricants and preservatives
Flushing sheet ¹⁾	Operating and installation instructions for the use of a mechanical seal
Operating & Installation Diagram ¹⁾	Operating and installation instructions for the use of a seal supply system, heating or cooling system
Documentation from suppliers ¹⁾	Technical documentation for components, for which ITT Bornemann GmbH is not the manufacturer
Spare parts list ¹⁾	Sectional drawing and listing of spare parts
Safety data sheets for auxiliary and operating materials ¹⁾	Information for the safe handling of auxiliary and operating materials

¹⁾ Only included in the scope of supply if the pump has been ordered correspondingly.

Technical terms

Tab. 2: Technical terms

Term	Meaning
System	Pump/pump assembly and all components connected by the operator
Component	Part which makes a defined contribution to the function of a system
Pump assembly	Pump, coupling and motor on base plate or profile frame
Pump system	Pump assembly with pipelines, fittings and control components





Info boxes and special characters



These info boxes highlight tips and recommendations as well as information for an efficient and trouble-free operation. At the beginning of individual chapters, these info boxes also contain references to supplementary documents that are relevant for the respective chapter and must be taken into account.

The following special characters are used in this manual to highlight instructions, references and lists:

Tab. 3: Info boxes and special characters

Special characters	Explanation
	Instruction
	Reference to sections of this manual
	Reference to supplementary documents
	Listing without a defined order

Copyright

This manual is protected by copyright.

The transfer of these instructions to third parties, duplication in any kind and form – even as extracts, – as well as the utilisation and/or communication of the contents are not permitted except for internal purposes without the written permission of ITT Bornemann GmbH (hereinafter referred to as the manufacturer). Non-compliance will result in compensation for damages. The manufacturer reserves the right to assert additional claims.

The copyright lies with the manufacturer:

© ITT Bornemann GmbH, Industriestr. 2, 31683 Obernkirchen, Germany

Warranty conditions

ITT Bornemann GmbH grants a warranty on the pump for 18 months after delivery or 12 months after commissioning, unless otherwise stipulated in the contract.

The warranty will become void, if:

- damages occur due to non-compliance with this manual
- operating conditions from the data sheet are not observed
- unauthorised modifications are made to the pump

Customer service

For questions about the pump, ordering spare parts and technical information, please contact ITT Bornemann GmbH using the following contact details:

ITT Bornemann GmbH

Industriestr. 2 | 31683 Obernkirchen (Germany)

Telephone: +49 5724 390-100 | Fax: +49 5724 390-290

Email: service.bornemann@itt.com | Internet: www.bornemann.com

In addition, ITT Bornemann GmbH is always interested in information and experiences resulting from the use of our products which can be valuable for making improvements to them.

Table of contents

1	Overview.....	9
2	Safety.....	11
2.1	Safety and warning information.....	11
2.2	Proper use.....	12
2.3	Improper use.....	12
2.4	Obligations of the operator.....	13
2.5	Personnel qualifications.....	14
2.6	Personal protective equipment.....	15
2.7	Labelling on the pump.....	16
2.8	Special hazards.....	16
2.9	Safety equipment.....	18
2.10	Securing against restarting.....	19
2.11	Environmental protection.....	20
3	Layout and function.....	21
3.1	Pump assembly.....	21
3.1.1	Pump.....	21
3.1.2	Coupling.....	21
3.1.3	Motor.....	22
3.2	Sealing supply system.....	22
3.3	Other components.....	22
3.3.1	Measuring devices.....	22
3.3.2	Frequency converter.....	22
4	Transportation and storage.....	23
4.1	Lifting and transporting the pump/pump assembly.....	23
4.2	Storing the pump.....	27
5	Preservative.....	28
5.1	Short-term preservation (up to maximum 3 months).....	28
5.2	Long-term preservation (from 3 months).....	29
5.3	Removing the preservative.....	30
6	Set-up and connection.....	31
6.1	Preparing the pump assembly.....	31
6.1.1	Installing the heat insulation (optional).....	31
6.1.2	Install pump on profile frame or base plate.....	32

6.1.3	Installing the coupling.	32
6.1.4	Assemble motor on profile frame or base plate.	33
6.2	Preparing the installation site.	33
6.3	Installing the pump assembly.	34
6.3.1	With machine feet.	34
6.3.2	With metal dowels (screwed).	34
6.3.3	With anchor bolt (cast).	35
6.4	Aligning the pump assembly.	36
6.5	Fitting the coupling guard.	41
6.6	Configuring the pipelines.	42
6.7	Connecting the pipelines.	45
6.8	Electrical connection.	47
7	Commissioning.	48
7.1	Prepare the pump.	48
7.2	Prepare sealing supply system (if provided).	49
7.3	Fill and bleed pump.	49
7.4	Switching on at commissioning.	50
8	Operation.	51
8.1	Starting operation.	51
8.2	Stopping operation.	51
8.3	Cleaning/sterilising the pump.	52
8.3.1	Cleaning/sterilising with CIP/SIP medium < 80 °C.	52
8.3.2	Cleaning/sterilising with CIP/SIP medium > 80 °C and pump with sealing supply system.	53
8.3.3	Cleaning/sterilising with CIP/SIP medium > 80 °C and pump without sealing supply system.	53
8.4	Provisions in the event of operational interruptions.	54
8.5	Operating the pump as a stand-by pump.	54
8.6	Winter operation.	55
9	Servicing.	56
9.1	Monitoring.	56
9.2	Maintenance schedule.	57
9.3	Lubrication.	59
9.3.1	Lubrication points.	60
9.3.2	Lubricant quantity.	60
9.3.3	Refilling the lubricating oil.	60
9.3.4	Changing the lubricating oil.	61

9.4	Repairs.....	61
9.4.1	Wearing parts.....	62
9.4.2	Ordering spare parts.....	62
9.4.3	Removing the pump.....	63
9.4.4	Sending the pump to the manufacturer.....	63
9.5	Cleaning agent.....	64
10	Troubleshooting.....	65
11	Putting out of operation.....	68
11.1	Emptying.....	68
11.2	Clean.....	68
12	Disposal.....	69
13	Index.....	71
	Appendix.....	75
	Noise level.....	77
	Declaration of no objection.....	78
	Declaration of incorporation in accordance with the EC machinery directive.....	79
	Declaration of conformity in accordance with the EC machinery directive.....	80

1 Overview



This chapter contains an overview drawing of the pump and an example illustration of the type plate. For specifications regarding dimensions and weight → dimensional drawing.

Screw pump SLH-5G



The following figure shows the pump only as an example and may differ from the pump supplied. For the order-specific representation of the pump, in particular the position of inlet and outlet nozzles → dimensional drawing.

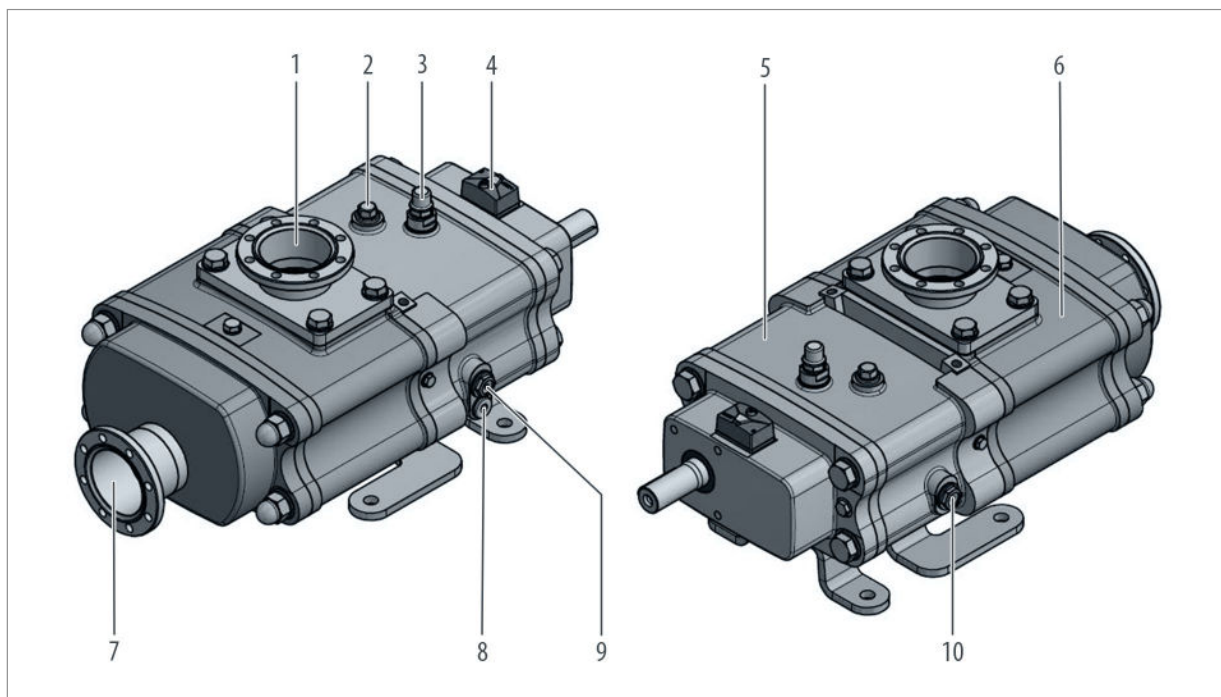

Fig. 1: SLH-5G

- 1 Outlet nozzle
- 2 Oil inlet
- 3 Ventilation filter
- 4 i-ALERT
- 5 Bearing casing
- 6 Pump casing
- 7 Inlet nozzle
- 8 Oil drain
- 9.10 Oil sight glass (on both sides)

Type plate on the pump (example)



The following figure shows the type plate on the pump only as an example. The type plate attached to the pump is always decisive.

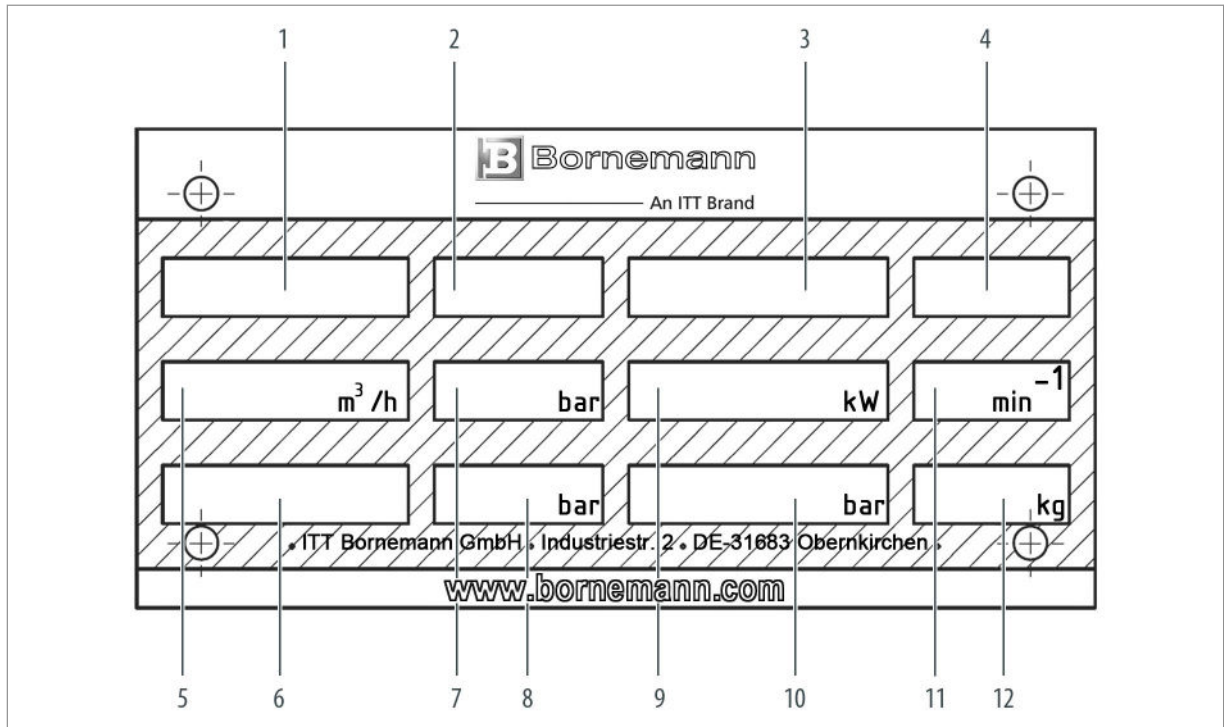

Fig. 2: Type plate on the pump

- 1 Order number
- 2 Serial number
- 3 Type
- 4 Year of manufacture
- 5 Pump capacity
- 6 Viscosity
- 7 Differential pressure
- 8 Inlet pressure
- 9 Output demand
- 10 Outlet pressure
- 11 Speed
- 12 Weight

Dimensions and weight



All detailed information on dimensions and weight are included in the dimensional drawing.

2 Safety



This chapter contains important information that must be observed under all circumstances in order to use the pump safely.

2.1 Safety and warning information

Safety and warning information is identified in this manual by warning signs and is introduced by signal words which indicate the extent of the risk.

DANGER

This combination of warning sign and signal word indicates an impending, dangerous situation, which could lead to death or serious injury if it is not avoided.

WARNING

This combination of warning sign and signal word indicates a potentially dangerous situation, which could lead to death or serious injury if it is not avoided.

CAUTION

This combination of warning sign and signal word indicates a potentially dangerous situation, which could lead to slight or minor injuries if it is not avoided.

NOTICE

This combination of warning sign and signal word indicates a potentially dangerous situation, which could lead to property damage if it is not avoided.

ENVIRONMENT

This combination of warning sign and signal word indicates possible dangers for the environment.

2.2 Proper use



The pump has an anticipated service life of 20 years.

- Only use the pump in compliance with this manual and all supplementary documents (→ 'Supplementary documents' on page 3).
- Have all work on the pump performed only by specialist personnel.
- Only operate the pump in technically perfect condition.
- Use pump exclusively for pumping the agreed pumped medium (→ data sheet).
- Observe the operating limits of the pump (→ data sheet).
- The pump is designed for a limited number of load cycles (N) between the pressureless state and the maximum permissible pressure according to the data sheet (N=1000, see AD 2000 leaflet S1, section 1.4 for this). During operation, any number of pressure fluctuations are permitted, as long as the load range of these does not exceed 10 % of the maximum permissible pressure.
- When pumping liquids containing solids: Comply with the limit values for the proportion of solids and grain size (→ data sheet).
- When pumping liquids containing gas: Observe the limit values for the gas contents (→ data sheet).
- Only operate the pump if the inlet and outlet lines are properly connected in the direction of flow (→ dimensional drawing).
- Avoid dry running: Only put the pump into operation with pumped medium and do not operate without pumped medium
- Avoid cavitation:
 - Fully open the inlet side valve (if available) during pump operation and do not use to regulate the pump capacity.
 - Fully open the outlet side valve (if available) during pump operation and do not use to regulate the pump capacity.
- Only operate the pump with suitable non-return protection.
- Only operate the pump with suitable differential pressure monitoring.
- Only operate the pump with suitable operating pressure limiting.

2.3 Improper use

Any use other than uses detailed under → Chapter 2.2 'Proper use' on page 12 shall be considered improper and is impermissible, for example:

- Operating if safety devices are removed or defective
- Operating if the inlet valve (if available) is not opened completely
- Operating if the outlet valve (if available) is not opened completely
- Throttling the outlet side
- Operating without suitable non-return protection
- Operating without suitable differential pressure monitoring
- Operating without suitable differential pressure limiting
- Using pressure safety valves to regulate the flow rate and the pressure
- Filling the pump while hot
- Filling the pump during operation
- Pumping acids or other corrosive liquids without approval from ITT Bornemann GmbH
- Pumping pure gases
- The pumping of explosive media as well as explosive mixtures, which could arise under certain operating conditions
- Installation and operation of the pump in an Ex-area
- Reversing the permissible pumping direction

- Spraying the pump with high-pressure jets or fire extinguishing equipment
- Failure to undertake measurements and checks for early damage detection
- Failure to observe the maintenance intervals
- Impermissible exchange of wearing parts
- Maintenance work was not carried out correctly
- Repair work was not carried out correctly
- Unauthorised modifications to the pump without approval from ITT Bornemann GmbH

2.4 Obligations of the operator

The pump is used in the commercial sector. The operator of the pump is therefore subject to the statutory occupational safety obligations.

In addition to the safety instructions in this manual, the safety, occupational safety and environmental protection regulations applicable to the area of application of the pump must be observed.

In particular, the following shall apply:

- The operator must inform himself/herself about the applicable occupational health and safety regulations and identify additional hazards arising from the special working conditions at the place of pump installation in a risk assessment. This must be implemented in the form of operating instructions for the operation of the pump.
- During the entire operating time of the pump, the operator must check whether the operating instructions drawn up by him/her correspond to the current status of the regulations and, if necessary, adapt them.
- The operator must clearly regulate and define the responsibilities for installation, operation, troubleshooting, maintenance and cleaning.
- The operator must ensure that all persons using the pump have read and understood this manual. In addition, he/she must regularly train the personnel and inform them about the dangers.
- The operator must provide the personnel with the necessary protective equipment and instruct them to wear the necessary protective equipment.

Furthermore, the operator is responsible for ensuring that the pump is always in perfect technical condition. Therefore the following shall apply:

- The operator must ensure that the maintenance intervals described in this manual are adhered to.
- The operator must have all safety devices checked regularly for functionality and completeness.

Hygiene-protected areas

The operator must comply with and implement further obligations arising from the hygiene regulations for the food industry if the pump is used in such an area.

The following applies here:

- The operator must provide the necessary protective equipment for all employees who enter hygiene-protected areas.
- The operator must ensure that all employees put on the necessary protective equipment before entering hygiene-protected areas and take this off before entering common rooms and dining areas.
- The operator must provide separate storage facilities for worn protective equipment and other clothing.
- The operator must ensure that the protective equipment is cleaned, disinfected and maintained.

2.5 Personnel qualifications

WARNING

Risk of injury if the personnel is not sufficiently qualified!

If unqualified personnel carry out work on the pump/pump assembly or are in the danger area of the pump, dangers arise which can cause serious injuries and considerable damage to the system.

- All activities must be carried out only by qualified personnel.
- Keep unqualified personnel away from danger areas.



Only persons who are expected to perform their work reliably may be permitted to be personnel. Persons whose reactions are affected, e. g. by drugs, alcohol or medication, are not permitted.

When selecting personnel, observe the age and occupation-specific regulations applicable at the site of operation.

This manual lists the qualifications of the personnel listed below for the various fields of activity:

Supervisor

The supervisor is a person authorised by the operator, who supervises assembly and repair work as well as operation (commissioning and decommissioning) and gives instructions regarding technical processes and mechanical work. The supervisor has been instructed by the operator and knows the residual risks arising from the system.

The supervisor is also able to carry out the tasks assigned to him/her on the basis of his/her knowledge and experience as well as knowledge of the relevant regulations, and can recognise and avoid possible dangers independently.

Transport specialist

The transport specialist is trained to carry out transport work using a crane or forklift truck. He/she is able to select suitable lifting equipment in accordance with the transport requirements and use it properly. For transport with a forklift truck, the transport specialist is trained on the device and is able to guide it.

The transport specialist is specially trained for the working environment in which he/she works and knows the relevant regulations.

Qualified mechanic

The qualified mechanic is trained to carry out installation, testing, maintenance and repair work on hydraulic and mechanical machines and systems. He/she is able to read, evaluate and use instructions and technical specifications to carry out work properly.

The qualified mechanic is specially trained for the working environment in which he/she works and knows the relevant standards and regulations. He/she is trained in the use of the product and can carry out the assigned tasks safely and without damaging the product. He/she also has knowledge of pneumatics and hydraulics in order to assess and avert the dangers posed by pneumatic and hydraulic systems as well as the reactions of the systems.

Qualified electrician

The qualified electrician is trained to carry out installation, testing, maintenance and repair work on electrical installations. He/she is able to read, evaluate and use instructions, circuit diagrams and technical specifications to carry out work properly.

The qualified electrician is specially trained for the working environment in which he/she works and knows the relevant standards and regulations.

2.6 Personal protective equipment

Personal protective equipment is used to protect people from health and safety impairments at work. Personnel must wear appropriate personal protective equipment during all work on the pump/pump assembly.

The following explains the personal protective equipment:

	<p>Protective work clothing</p> <p>Protective work clothing protects the torso, arms and legs from dangers such as:</p> <ul style="list-style-type: none"> ■ Abrasion and grazing ■ Risk of injury due to moving parts ■ Burns due to hot surfaces or hot liquids ■ Scalds due to hot vapours ■ Injuries due to coming into contact with chemicals <p>The type of protective work clothing must be selected according to the area of application.</p>
	<p>Safety shoes</p> <p>Safety shoes protect the feet from bruising, falling parts and pointy or sharp objects. They also protect against slipping on slippery surfaces.</p>
	<p>Industrial safety helmet</p> <p>An industrial safety helmet protects the head against falling objects, swinging loads and impacts on stationary objects.</p>
	<p>Safety goggles</p> <p>Safety goggles protect the eyes from flying parts and liquid splashes.</p>
	<p>Hearing protection</p> <p>Hearing protection protects against hearing damage caused by exposure to noise.</p>
	<p>Protective gloves</p> <p>Protective gloves protect the hands from abrasion and grazing, punctures or deeper injuries, as well as from contact with hot surfaces.</p> <p>Chemical-resistant protective gloves protect hands from aggressive chemicals.</p> <p>The type of protective gloves must be selected according to the area of application.</p>

2.7 Labelling on the pump

WARNING

Danger from illegible signs!

In the course of time, stickers and signs may become dirty or otherwise unrecognisable, so that dangers cannot be recognised and necessary operating instructions cannot be followed. This results in a risk of injury.

- Keep all safety, warning and operating instructions in a clearly legible condition at all times.
- Immediately replace damaged signs or stickers.

The following symbols are located in the work area. They refer to the immediate environment in which they are installed.



Hot surface

Hot surfaces, such as hot machine parts, containers or materials, but also hot liquids, are not always noticeable. Do not touch them without heat-resistant protective gloves.

2.8 Special hazards

The pump/pump assembly has been designed in accordance with state-of-the-art and current safety regulations. However, special hazards remain that require careful action. These hazards and the resulting behaviours and provisions are listed below.

Electrical current

DANGER

Risk of death due to electrical current!

In case of contact with live parts, there is an immediate risk of death due to electric shock. Damage to the insulation or individual components can be life-threatening.

- Only allow work to be carried out on the electrical systems by qualified electricians.
- If the insulation is damaged, immediately switch off the power supply and arrange for a repair.
- Before starting work on active parts of electrical systems and equipment, ensure that they are in a voltage-free state and that they remain so for the duration of the work. Observe the 5 safety rules:
 - Switch off.
 - Secure against being switched back on.
 - Determine that there is no current.
 - Earth and short-circuit.
 - Cover or isolate neighbouring live parts.
- Never bridge fuses or put them out of service. When replacing fuses, observe the correct current rating.
- Keep moisture away from live parts. This can lead to a short circuit.

Hot pumped medium

WARNING

Risk of scalding due to hot pumped medium!

Pumped medium can exhibit high temperatures. Contact with escaping pumped medium can cause severe scalding.

- Always wear heat-resistant protective work clothing, safety footwear, safety goggles and protective gloves during all work.
- Before all work on the pump: Switch off the pump, close the shut-off valves and wait until the pump has cooled down and the pressurised components of the pump are depressurised.

Hot surfaces

WARNING

Risk of injury due to hot surfaces!

The pumped media, the streamed-through components and the drive can exhibit high temperatures. Skin contact with hot surfaces causes severe burns.

- Always wear heat-resistant protective work clothing and protective gloves when working near hot surfaces.
- Before all work on the pump: Switch off the pump, close the shut-off valves and wait until the pump has cooled down.

High operating pressure

WARNING

Risk of injury from media under pressure!

The pump can be used to pump pumped media at high pressures. By opening pressurised components and through leakages, media can escape under high pressure and cause injuries.

- Wear personal protective equipment: Protective clothing, safety footwear, safety goggles, chemical-resistant protective gloves.
- Only allow work to be carried out on the system by qualified personnel.
- Do not disassemble any components during operation.
- Before working on components under pressure: Relieve components of pressure completely in the safe area and ensure this condition for the duration of the work.
- Regularly check pressurised components for flawless condition.

Moving parts

WARNING

Risk of death due to moving parts!

When working near moving parts, e. g. the drive spindle, hair may be drawn in, body parts may be crushed or other serious injuries may be caused.

- Do not interfere with moving parts during operation and do not handle moving parts.
- Before performing tasks, switch off moving components and secure them against being switched on again.
- Keep covers closed during operation.
- Pay attention to the stopping time: Before opening the covers, ensure that all parts are stationary.

Noise

WARNING

Risk of injury from noise!

In the area of the pump and drive, the noise level may exceed the permissible limit value and cause permanent hearing damage.

- When working in the immediate vicinity, always wear hearing protection.

Slippery surfaces

CAUTION

Risk of injury due to slippery surfaces!

Leaks can occur in the area of the pump. This can cause slippery surfaces and lead to falls and injuries.

- Regularly clean accessible surfaces to remove slippery deposits and leaks.

2.9 Safety equipment

WARNING

Risk of death due to malfunctioning safety equipment!

In the case of safety equipment that is not functioning or has been disabled, there is a risk of serious injury or death.

- Before starting work, check that all safety equipment is in working order and properly installed.
- Never disable or override safety equipment.
- Ensure that all safety equipment is accessible at all times.

Providing safety equipment

- Ensure that contact protection is provided for hot, cold and moving parts.
- Ensure that sufficient earthing and potential equalisation are guaranteed.
- For maintenance and repair work: Provide electrical disconnection devices.
- Provide a suitable non-return device in the system, which prevents uncontrolled back-flow of the pumped medium when the pump is at a standstill.
- Provide suitable operating pressure limiting, which reliably prevents the maximum permissible operating pressure of the system from being exceeded.
- Provide a suitable differential pressure monitoring system for the pump.

Safe handling of EMERGENCY STOP buttons

- If necessary, include EMERGENCY STOP buttons for switching off the system at a sufficient safety distance from the system.
- Remember the positions of all EMERGENCY STOP buttons, in order to be able to react quickly in an emergency.
- Always keep all EMERGENCY STOP buttons freely accessible.
- Only reset the EMERGENCY STOP once the danger has been rectified.

2.10 Securing against restarting

WARNING

Risk of death due to unauthorised or uncontrolled restart!

Unauthorised or uncontrolled restarting can result in serious injuries or even death.

- During all work on the system: Ensure that the system is secured against unauthorised or uncontrolled restarting.
- After completion of work on the system: Ensure that no persons are left in the danger zone before the system is switched on again.

The following provisions can be implemented to secure the system against being switched back on:

- Keep removed circuit breakers or fuse links in a safe place and replace them with suitable locking plugs or dummy elements.
- Lock the circuit breaker, switch cabinet or fuse box and keep the lock key in a safe place.
- Attach suitable switching prohibited signs or warning signs.

2.11 Environmental protection

ENVIRONMENT

Danger to the environment from incorrect handling of environmentally hazardous substances!

Incorrect handling of environmentally hazardous substances, especially incorrect disposal, can cause considerable damage to the environment.

- Always observe the information below regarding the handling of environmentally hazardous substances and their disposal.
- If environmentally hazardous substances accidentally enter the environment, take appropriate provisions immediately. If in doubt, inform the relevant local authority of the damage and ask for appropriate provisions to be implemented.

Lubricants

Lubricants such as oils contain toxic substances. They must not get into the environment. Disposal must be carried out by a specialist disposal company.

Pumping medium

In order to ensure proper disposal, local regulations, laws and technical regulations must be observed and complied with if applicable.

Cleaning agent

Cleaning agents are irritants and contain toxic substances. They must not get into the environment.

In order to ensure proper disposal, local regulations, laws, technical regulations, etc. and the safety data sheets for the respective substances must be observed and complied with.

Preservative agents

Preservatives are irritants and contain toxic substances. They must not get into the environment.

In order to ensure proper disposal, local regulations, laws, technical regulations, etc. and the safety data sheets for the respective substances must be observed and complied with.

3 Layout and function



This chapter provides detailed information on the individual components and their functions. Depending on the scope of delivery, either a single pump or a pump assembly has been supplied.

3.1 Pump assembly

3.1.1 Pump



An overview of the pump is provided in chapter 1 of this operating manual (Fig. 1).

Heating (optional)

Only if the pump has been correspondingly ordered: If required, the pump can be operated with an additional heating system. For specifications regarding the intended connections → dimensional drawing.

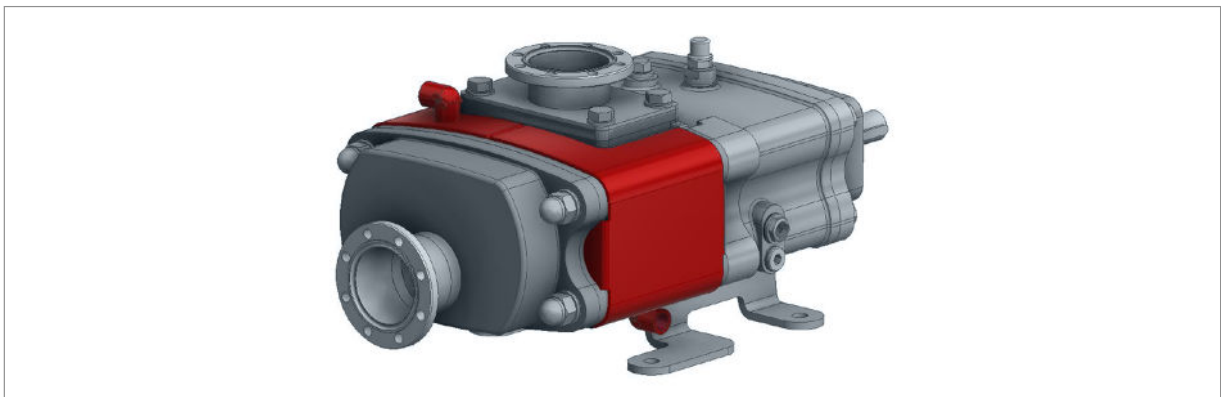

Fig. 3: Heating jacket (example)

3.1.2 Coupling



For further information on the coupling: Observe the technical documentation from the manufacturer of the coupling.

The coupling connects the pump to the motor and serves to transmit power from the motor to the pump. A coupling guard protects against external interference.

3.1.3 Motor



For further information on the motor: Observe the technical documentation from the manufacturer of the motor.

The motor serves to drive the pump. Depending on the scope of delivery, a frequency converter can be provided to control the motor.

3.2 Sealing supply system



Depending on the scope of delivery, a sealing supply system may be provided for the mechanical seals of the pump.

For further information on the sealing supply system: Observe the dimensional drawing, operating and installation diagram, as well as the technical documentation from the manufacturer of the sealing supply system.

The sealing supply system supports the mechanical seals with respect to the lubrication and cooling. The system comprises a closed circulation circuit that leads from the oil-buffered seal tank to the sealing cavity of the mechanical seal and back to the oil-buffered seal tank.

If a circulation pump is included in the delivery: The circulation pump improves the cooling effect of the sealing supply system through increased circulation.

3.3 Other components

3.3.1 Measuring devices



Depending on the scope of delivery, the pump can be equipped with different measuring devices.

For further information on the measuring devices: Observe the dimensional drawing and technical documentation from the respective manufacturer.

Measuring devices can be used to monitor temperature, pressure, vibrations and level at the pump.

i-ALERT

The pump is equipped as standard with the i-ALERT machine monitoring device, which continuously measures the vibrations and temperature of the pump. For further information on i-ALERT → manufacturer's operating manual.

3.3.2 Frequency converter



Depending on the scope of delivery, a frequency converter can be provided to control the motor. For further information on the frequency converter: Observe the technical documentation from the manufacturer of the frequency converter.

4 Transportation and storage



This chapter contains information on lifting, transporting and storing the pump. For specifications regarding dimensions and weight → dimensional drawing.

4.1 Lifting and transporting the pump/pump assembly

WARNING

Risk of death due to suspended loads!

When lifting loads, there is a danger of fatal injury from falling or uncontrolled swivelling parts.

- Ensure that there are no persons, objects or obstacles in the swivelling area of the cargo during transport.
- Use only approved hoists and slings with sufficient load-bearing capacity.
- Do not attach to built-on components.
- Ensure that the slings are securely seated.
- Do not use torn or abraded ropes and belts.
- Do not lay ropes and straps on sharp edges and corners, do not knot or twist them.

WARNING

Risk of injury from falling or tipping cargo!

Cargo may have an eccentric centre of gravity. Cargo can tip over and fall when incorrectly fastened. Serious injuries can be caused by falling or tipping cargo.

- Observe centre of gravity.
- When transporting by crane, attach the crane hook so that it is above the centre of gravity of the cargo.
- Lift the cargo carefully and observe if it tips. If necessary, change the fastening position.

NOTICE

Property damage due to improper transportation!

- Transport only by adequately trained and qualified personnel.
- Do not allow the transport piece to hit or bump against anything.
- Do not allow the transport piece to fall down or tip over.

Personnel:

- Supervisor
- Transport specialist

Protective equipment:

- Protective work clothing
- Safety shoes
- Industrial safety helmet
- Safety goggles
- Protective gloves

Transport by crane

Cargo can be transported directly by crane under the following conditions:

- The pump is emptied of all media that would pose a risk to health and/or the environment during transport due to uncontrolled leakage.
- Cranes and hoists must be designed for the weight of the cargo.
- Load carrying equipment and lifting gear must be designed for the weight of the cargo.
- The operator must be authorised to operate the crane.

Lifting (without lifting lugs)

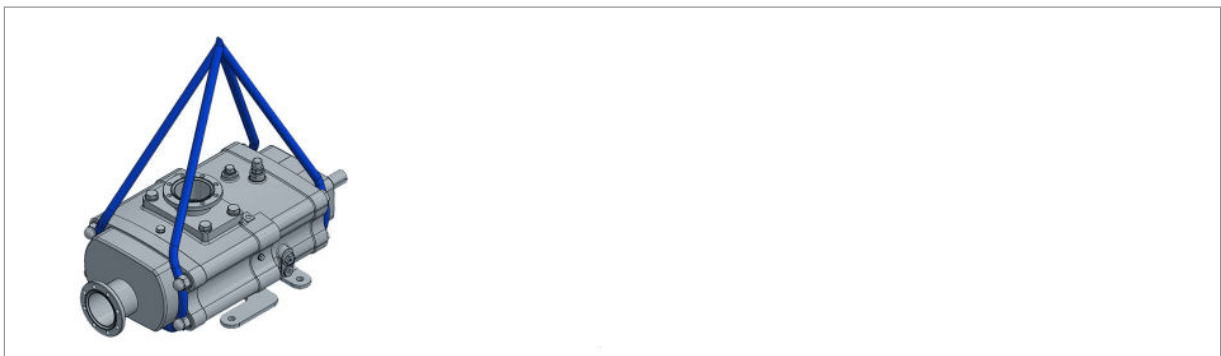

Fig. 4: Lifting the pump

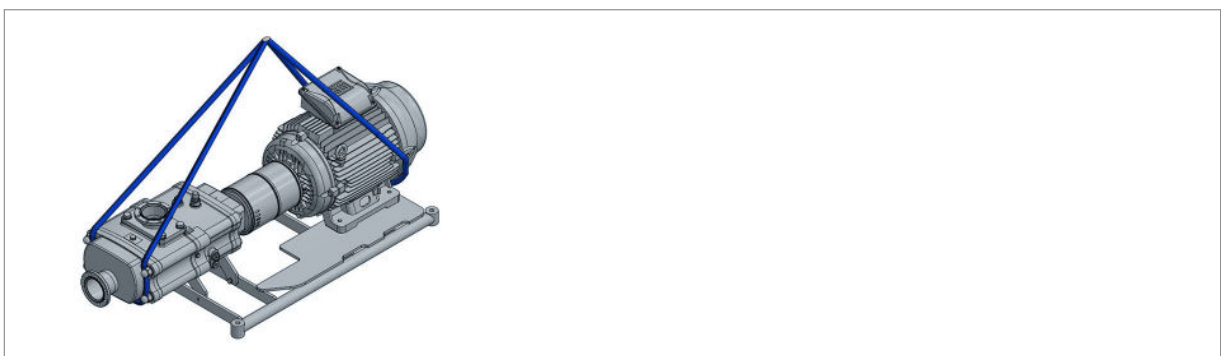





Fig. 5: Lift the pump assembly

1.  Fasten cables, straps or multi-point hangers in accordance with *Fig. 4* or *Fig. 5*.
2.  Ensure that the transported item is hanging straight and observe the eccentric centre of gravity if necessary.
3.  Lift the transported item and start transport.

Lifting with lifting lugs



The lifting lugs must only be used for lifting the individual pump.
Lifting the entire pump assembly by means of lifting lugs is not permitted!

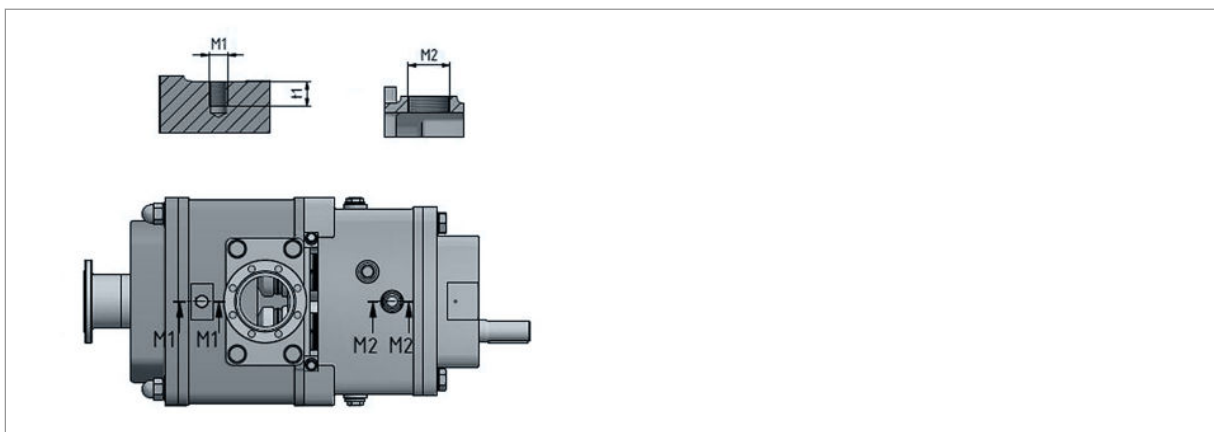

Fig. 6: Thread sizes for lifting lugs (see table below for details)

Tab. 4: Thread sizes for lifting lugs

SLH-5G Size	M1	t1 [mm]	M2
2000	M10	16	M27x2
3000	M12	16	M27x2
4000	M16	20	M27x2

1. ➤ Select lifting lugs according to Fig. 6 and ➔ Tab. 4 'Thread sizes for lifting lugs' on page 25 and attach them to the pump.
2. ➤ Fasten cables, straps or multi-point hangers in accordance with Fig. 7.

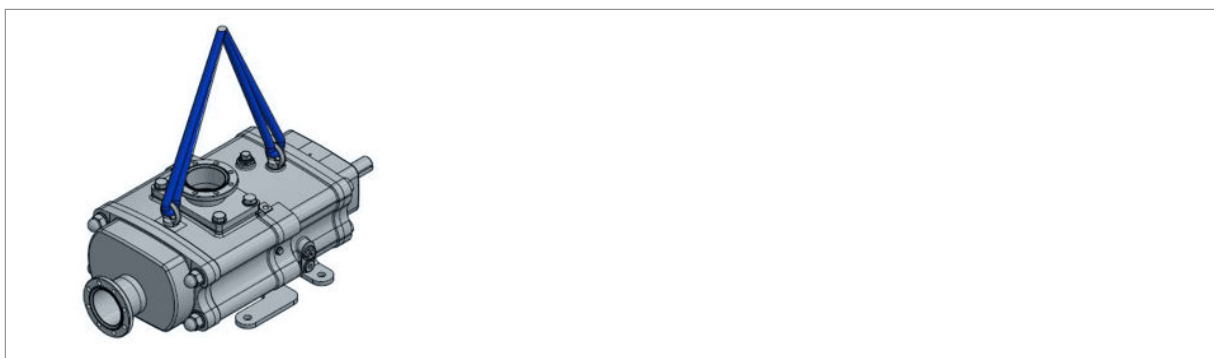

Fig. 7: Lifting the pump with lifting lugs

3. ➤ Ensure that the transported item is hanging straight and observe the eccentric centre of gravity if necessary.
4. ➤ Lift the pump and start transport.

Lifting with crossbeam

The following prerequisites must be met in order to transport the transported item with a lifting beam:

- The lifting beam and cables must be designed for the weight of the cargo.
- Slings must be designed for the weight of the cargo.

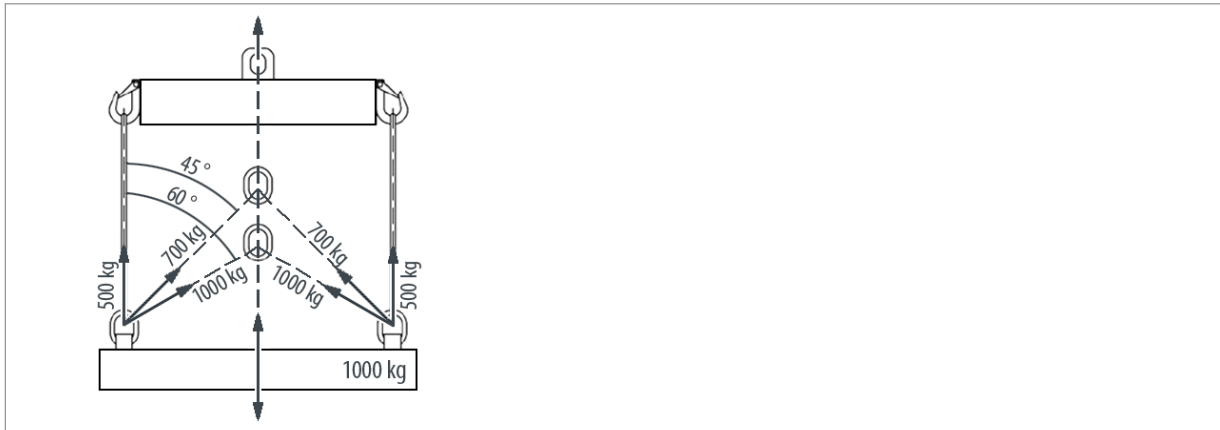

Fig. 8: Single crossbeam

Transport by forklift truck

The cargo can be transported with a forklift truck under the following conditions:



- The pump is emptied of all media that would pose a risk to health and/or the environment during transport due to uncontrolled leakage.
 - The forklift truck must be designed for the weight of the cargo.
 - The forklift driver must be authorised to drive industrial trucks with a driver's seat or operator's platform in accordance with local regulations.
1. ➤ Move the forklift truck with the forks between the bars of the transported item.
 2. ➤ Retract the forks so far that they protrude on the opposite side.
 3. ➤ Ensure that the transported item cannot tilt if its centre of gravity is off-centre.
 4. ➤ Lift the transported item and start transport.

4.2 Storing the pump

! NOTICE

Property damage due to inadequate preservation!

– Always preserve the pump properly before storage (↔ Chapter 5 'Preservative' on page 28).

1.  Seal off the inlet and outlet ports with plastic covers.
2.  Protect seals against dust and damage.
3.  Store pump under the following conditions:
 - Do not store outdoors.
 - Ambient temperature: 5-25 °C.
 - Protect from direct sunlight.
 - Protect from frost.
 - Store in a dry and dust-free place.
 - Relative humidity: 0-20 %.
 - Do not expose to aggressive media.
 - Protect from rodents.
 - Avoid mechanical shocks.
 - Pump: Rotate the shaft once per month (approx. 30°).
 - For storage periods longer than 3 months: Check the general condition of all parts and packaging regularly.



Following storage periods exceeding 3 years: ITT Bornemann GmbH should be contacted in order to put the pump back into operation.

5 Preservative



This section contains information on preservation of the pump and removing the preservation.

For information on preserving other components: Observe the documentation from the manufacturer of the respective component.

! NOTICE

Property damage due to deficient/lacking preservation!

- Ensure proper preservation in order to avoid corrosion damage.

Personnel:

- Supervisor
- Qualified mechanic

Protective equipment:

- Protective work clothing
- Safety shoes
- Safety goggles
- Protective gloves

5.1 Short-term preservation (up to maximum 3 months)



Unless ordered otherwise, the bearing casing of the pump is filled with lubricating oil by ITT Bornemann GmbH before delivery. The quantity of lubricating oil added corresponds to the quantity required for operation. The pump is therefore sufficiently preserved for a maximum period of 3 months.

- Make sure that the bearing casing of the pump is filled with sufficient lubricating oil (→ Chapter 9.3.3 'Refilling the lubricating oil' on page 60).

5.2 Long-term preservation (from 3 months)

1. Drain lubricating oil from the bearing casing into a suitable collecting container. The collecting container must be able to collect the following quantities of lubricating oil:

Tab. 5: Lubricating oil quantities

SLH-5G Size	Bearing casing approx. oil quantity [l]
2000	0.60
3000	1.20
4000	2.40

2. Make sure that the oil outlet on the bearing casing is closed again.
3. Completely fill the bearing casing with preservative (oil ISO VG 68-150). The following quantities of preservative are required:

Tab. 6: Preservative quantities

SLH-5G Size	Bearing casing approx. oil quantity [l]
2000	2
3000	3
4000	6

4. Close the oil inlet on the bearing casing with a screw plug.
5. Remove the ventilation filter (Fig. 9) from the bearing casing and store it safely. Then close the opening with a blind plug.

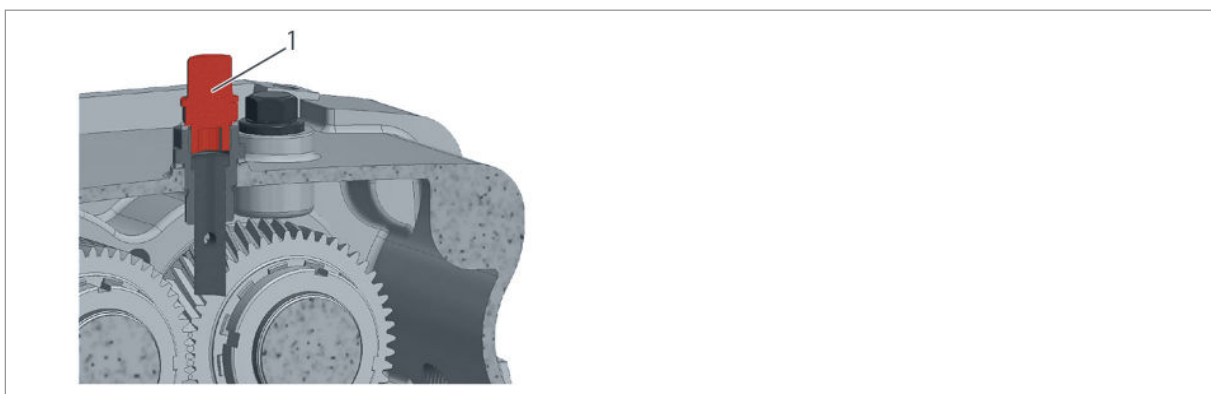

Fig. 9: Ventilation filter on the bearing casing

- 1 Ventilation filter

6. Seal off the inlet and outlet ports with plastic covers.



Following storage periods exceeding 3 years: ITT Bornemann GmbH should be contacted in order to put the pump back into operation.

5.3 Removing the preservative

After short-term preservation:

- ➔ Check the oil level and, if necessary, top up lubricating oil before commissioning (➔ Chapter 9.3.3 'Refilling the lubricating oil' on page 60).

After long-term preservation:

 Following storage periods exceeding 3 years: ITT Bornemann GmbH should be contacted in order to put the pump back into operation.

1. ➔ Remove the blind plug and replace the ventilation filter (Fig. 10) on the bearing casing.

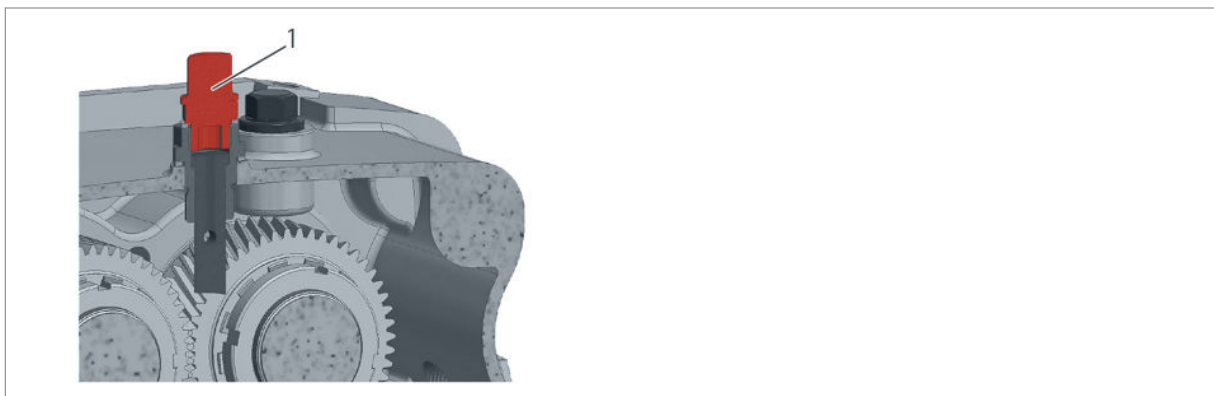

Fig. 10: Ventilation filter on the bearing casing

- 1 Ventilation filter

2. ➔ Drain preservative agent completely out of the bearing casing into a suitable collecting container. The collecting container must be able to collect the following quantities of preservative:

Tab. 7: Preservative quantities

SLH-5G Size	Bearing casing approx. oil quantity [l]
2000	2
3000	3
4000	6

3. ➔ Make sure that the oil outlet on the bearing casing is closed again.
4. ➔ Fill up with lubricating oil (➔ Chapter 9.3.3 'Refilling the lubricating oil' on page 60) and close the oil inlet again with the screw plug.

6 Set-up and connection



This chapter contains information on setting up and aligning the pump assembly, as well as connecting pipelines and the electrics.

Personnel:

- Supervisor
- Transport specialist
- Qualified mechanic
- Qualified electrician

Protective equipment:

- Protective work clothing
- Safety shoes
- Industrial safety helmet
- Safety goggles
- Protective gloves

6.1 Preparing the pump assembly

6.1.1 Installing the heat insulation (optional)

! NOTICE

Property damage due to improper heat insulation!

- Always install the heat insulation so that a leak on the pump can be safely detected at all times.

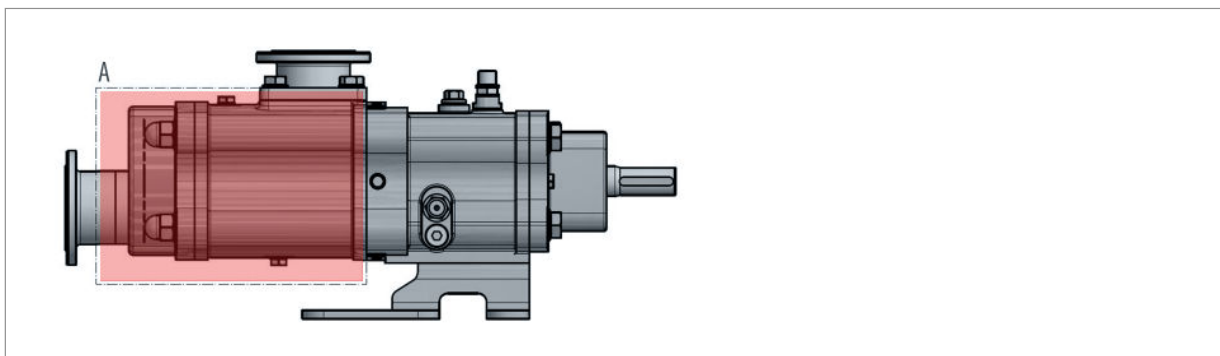

Fig. 11: Limits for heat insulation (A)

→ Installing the heat insulation (Fig. 11, area A).

6.1.2 Install pump on profile frame or base plate



Only required when the pump assembly is completed at the site of installation.



If the pump was ordered without profile frame or base plate: Design the profile frame or base plate so that torsions and impermissible vibrations are safely prevented during operation. Provide height compensation for the drive.

1. → Lift the pump.
2. → Set pump on profile frame or base plate.
3. → Turn in screws to fasten, but do not fasten tight.

6.1.3 Installing the coupling



Only required when the pump assembly is completed at the site of installation.

1. → For further information and in the case of special couplings: Observe the documentation from the manufacturer of the coupling.
2. → Coat motor shaft ends with molybdenum disulphide (for example, Molykote).
3. → Insert adjusting spring.

4. → **! NOTICE**

Property damage due to installation errors!

- Do not tilt coupling halves when sliding on.
- Do not impact or knock any pump, coupling or motor parts.
- Do not push on the coupling half by heating it.

Push on the motor-side coupling half according to the manufacturer's instructions (→ Operating manual coupling).

5. → Tighten the set screws on both coupling halves on the motor side, taking into consideration the tightening torques.

6.1.4 Assemble motor on profile frame or base plate



Only required when the pump assembly is completed at the site of installation.



If the pump was ordered without profile frame or base plate: Design the profile frame or base plate so that torsions and impermissible vibrations are safely prevented during operation. Provide height compensation for the drive.

The pump-side coupling half including separating can is pre-fitted with a transition fit as standard.

1. → For further information: Observe the documentation from the manufacturer of the motor as well as the documentation from the manufacturer of the coupling.
2. → Lift the motor.
3. → Set motor on profile frame or base plate.
4. → Bring together coupling halves. Maintain the specified gap dimension between the coupling halves (→ Operating manual coupling).
5. → Adapt the motor shaft end to the height of the pump shaft end using suitable shims on the motor.
6. → Turn in screws to fasten, but do not fasten tight.

6.2 Preparing the installation site

Ambient conditions

- Ensure that the installation site fulfils the following requirements:
 - protected against direct sunlight
 - protected against frost
 - no effects due to wind loads
 - no effects from external vibrations (e. g. earthquakes) on the pump
 - sufficient lighting
 - sufficient space so that the pump assembly is freely accessible from all sides
 - sufficient space to be able to perform all maintenance and repair work, including the installation and removal of components
 - sufficient protection against external impacts (e. g. impact of objects, collision).

Foundation and base

- Ensure that the foundation and base fulfils the following requirements:
 - Level
 - Clean (no oil, dust or other contaminants)
 - Service weight of the pump assembly and all operational forces can be absorbed
 - The stability of the pump assembly is ensured

6.3 Installing the pump assembly



The possible installation and mounting variants for the pump assembly are described below:

- With machine feet: ➔ Chapter 6.3.1 'With machine feet' on page 34
- With metal dowels (screwed): ➔ Chapter 6.3.2 'With metal dowels (screwed)' on page 34)
- With anchor bolt (cast): ➔ Chapter 6.3.3 'With anchor bolt (cast)' on page 35)

6.3.1 With machine feet



The distance between the pump/pump assembly and the ground should be at least 50 mm so that dirt cannot accumulate unnoticed underneath.

1. ➔ Transport the pump assembly to the installation site (➔ Chapter 4.1 'Lifting and transporting the pump/pump assembly' on page 23).
2. ➔ Place the pump assembly on a suitable base.
3. ➔ Align the pump assembly:
 - Undo nuts (no. 1 in Fig. 12) on machine feet (no. 2 in Fig. 12).
 - Adjust height of machine feet.
 - Tighten the nuts.

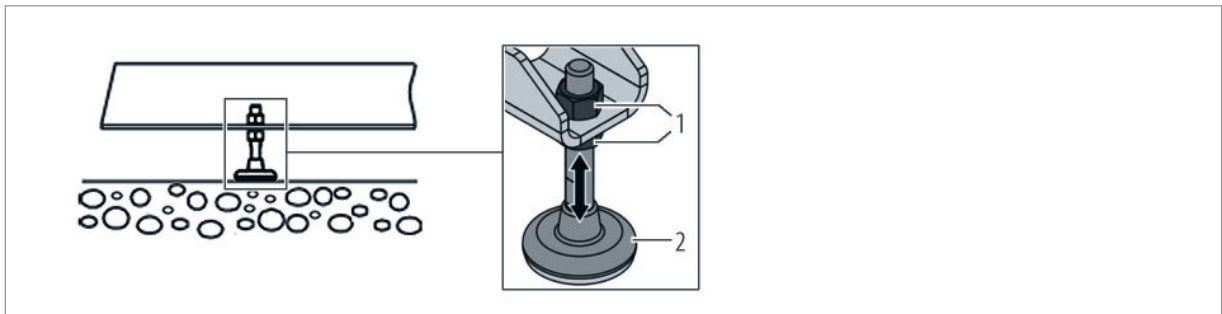

Fig. 12: Align the pump assembly

4. ➔ Repeat step 3 for all further levelling machine feet (if necessary).
5. ➔ Check the horizontal alignment of the pump assembly using a spirit level. If the pump assembly is not correctly aligned: Correct the alignment.

6.3.2 With metal dowels (screwed)

1. ➔ Transport the pump assembly to the installation site (➔ Chapter 4.1 'Lifting and transporting the pump/pump assembly' on page 23).
2. ➔ Place the pump assembly on the foundation.
3. ➔ Fasten pump assembly to the foundation with suitable screws and metal dowels.
4. ➔ Check the horizontal alignment of the pump assembly using a spirit level. If the pump assembly is not correctly aligned: Correct the alignment.

6.3.3 With anchor bolt (cast)

! NOTICE

Property damage due to base plate tension!

A tensioning of the base plate may prevent coupling alignment and result in pump damage.

- Mount the base plate on a level foundation.
- It is essential to observe the alignment tolerances.

Placing the pump assembly on the foundation

1. ➔ Transport the pump assembly to the installation site (➔ Chapter 4.1 'Lifting and transporting the pump/pump assembly' on page 23).
2. ➔ Place the pump assembly on the foundation.
3. ➔ Hook the foundation bolts (no. 1 in Fig. 13) into the base plate fastening holes from below.

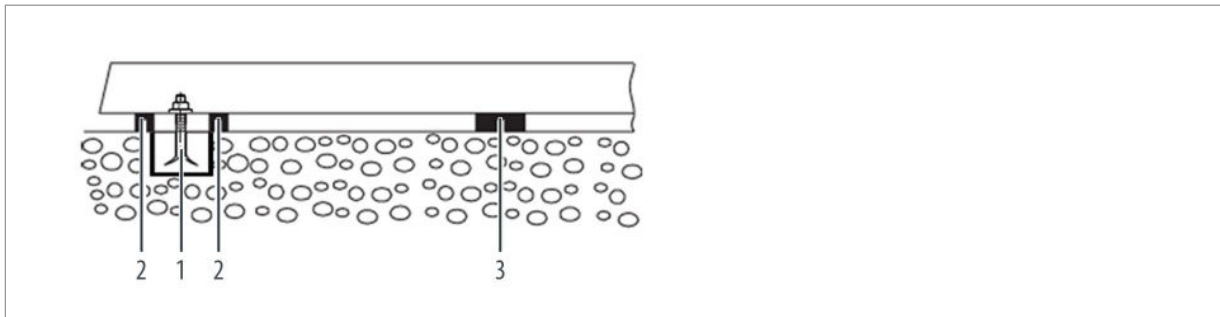

Fig. 13: Placing the pump assembly on the foundation

- 1 Foundation bolt
- 2 Steel fixings, left and right of foundation bolt
- 3 Additional steel fixing (distance of anchor holes > 750 mm)

4. ➔ Place the pump assembly on the foundation.
5. ➔ Sink the foundation bolts (no. 1 in Fig. 13) into the prepared anchor holes.



Take into account the minimum dimension for the anchor holes.

6. ➔ Using steel fixtures, align the pump assembly in accordance with the height and system dimensions as follows:
 - To the left and right of each foundation bolt (no. 1 in Fig. 13), arrange one steel fixture (no. 2 in Fig. 13) respectively
 - If the distance from the anchor holes is greater than 750 mm, locate additional steel fixtures (no. 3 in Fig. 13) centrally on either side of the base plate
7. ➔ Ensure that the base plate and steel fixtures lie flush.

8. → Using a digital spirit level (or alternatively, a laser alignment device), check in longitudinal and transverse directions that the following tolerances are not exceeded:

Permissible tolerances for the evenness of support points in relation to each other:

- Base plate shorter than or equal to 3 m: **1 mm tolerance**
- Base plate longer than 3 m: **2 mm tolerance**

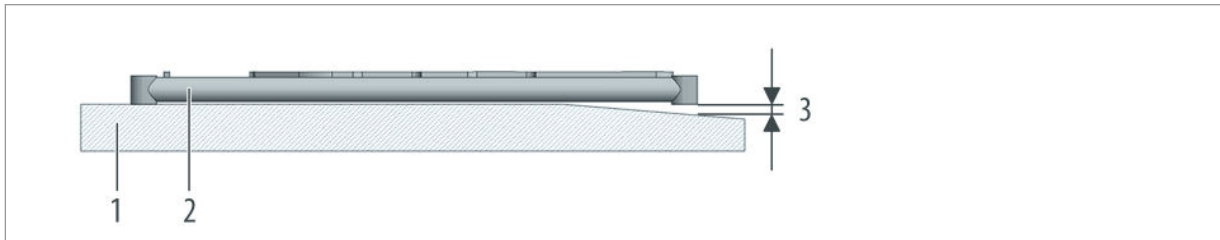

Fig. 14: Aligning the base plate

- 1 Foundation
- 2 Base plate
- 3 Tolerance

9. → Repeat the process until the base plate is correctly aligned.

Fastening the pump assembly

1. → Cast the anchor holes using a casting mortar.
2. → Once the mortar grouting compound has set, tighten the screws on the steel frame (base plate) evenly.
3. → Compensate for any unevenness in the fixing surface using spacers adjacent to each screw.
4. → Tighten screws with appropriate tightening torque.

6.4 Aligning the pump assembly

! NOTICE

Material damage due to incorrect coupling alignment!

- With height, lateral or angular offset: Align the motor precisely to the pump.
- For detailed information and for special couplings (→ Documentation from the manufacturer).

Determining alignment tolerances

1. Determine alignment tolerances for pump (→ 'Pump alignment tolerances' on page 37).
2. Determine alignment tolerances for coupling.



Permissible deviations and dimensions: Manufacturer's specifications (→ Operating manual coupling).

3. Determine alignment tolerances for the motor.



Permissible deviations and dimensions: Manufacturer's specifications (→ Operating manual motor).

4. Determine the lowest value from the ascertained alignment tolerances (pump, coupling, motor).

Pump alignment tolerances

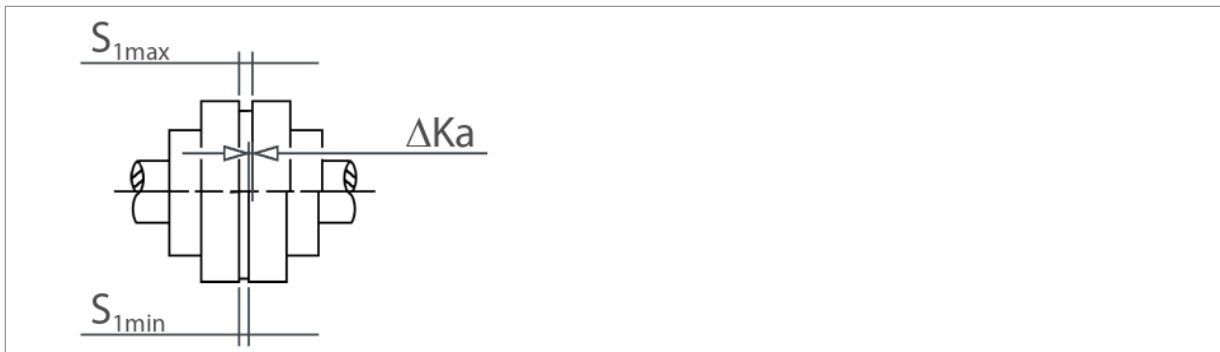

Fig. 15: Axial offset

S_{1max} maximum axial gap
 S_{1min} minimum axial gap
 ΔKa permissible axial gap in mm

Tab. 8: Axial offset

SLH-5G Size	Axial offset ΔKa [mm]
2000	+1.0
3000	+1.0
4000	+1.0

Set-up and connection

Aligning the pump assembly

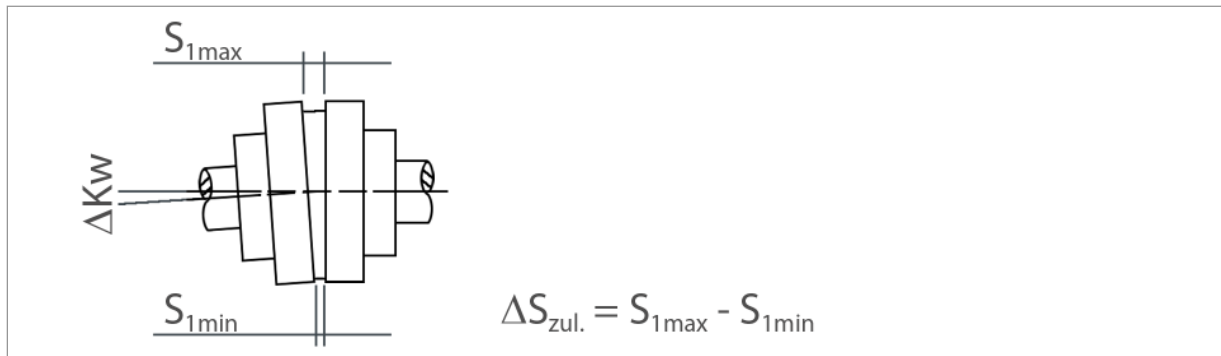

Fig. 16: Angle offset

- S_{1max} maximum axial gap
- S_{1min} minimum axial gap
- ΔKw permissible angle offset in degrees
- ΔS_{perm.} permissible angle offset in mm

Tab. 9: Angle offset

SLH-5G Size	Angle offset ΔS _{perm} [mm]							
	750 rpm	1000 rpm	1200 rpm	1450 rpm	1750 rpm	2000 rpm	2400 rpm	2800 rpm
2000	0.31	0.27	0.24	0.22	0.20	0.19	0.17	0.16
3000	0.35	0.31	0.28	0.26	0.23	0.22	0.20	0.18
4000	0.40	0.35	0.32	0.29	0.26	0.25	0.22	0.21

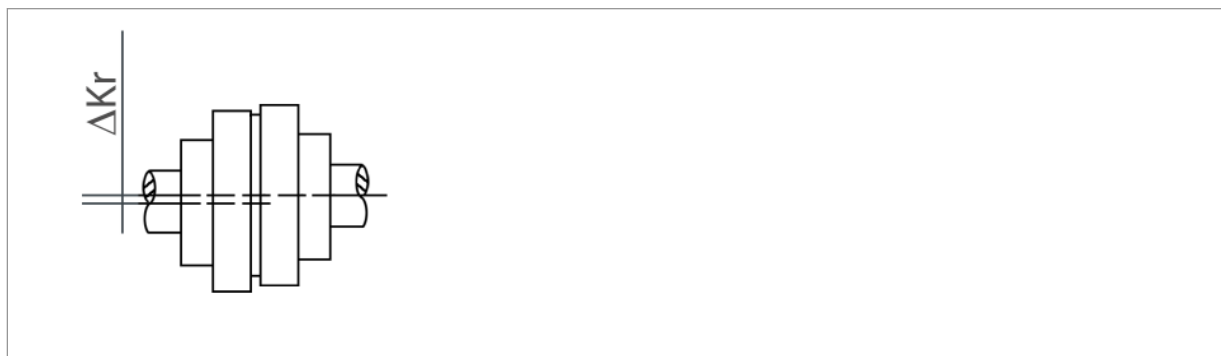

Fig. 17: Radial offset

- ΔKr permissible radial offset in mm

Tab. 10: Radial offset

SLH-5G Size	Radial offset ΔKr [mm]							
	750 rpm	1000 rpm	1200 rpm	1450 rpm	1750 rpm	2000 rpm	2400 rpm	2800 rpm
2000	0.31	0.27	0.24	0.22	0.20	0.19	0.17	0.16
3000	0.35	0.31	0.28	0.26	0.23	0.22	0.20	0.18
4000	0.40	0.35	0.32	0.29	0.26	0.25	0.22	0.21

Determining peak height changes

1. Determine peak height change of the pump:

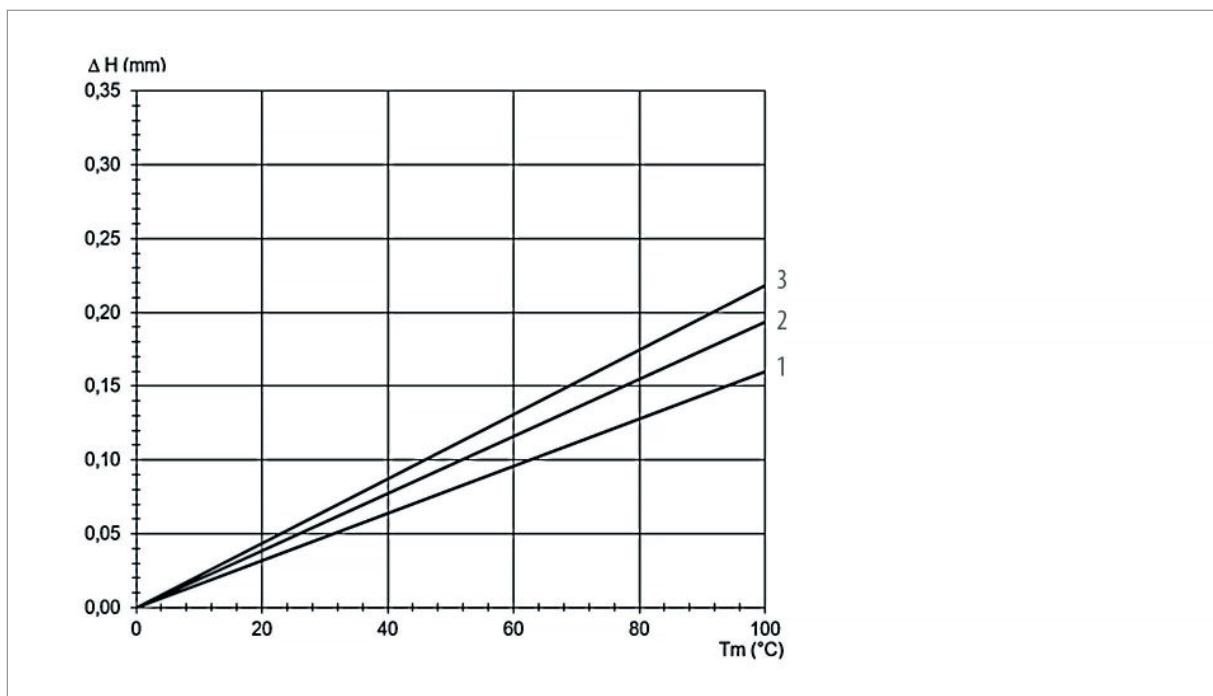

Fig. 18: Peak height change

- ΔH (mm) Peak height change
 T_m (°C) Temperature median value $T_m = (T_2 - T_1) / 2$
 T_1 = Ambient temperature
 T_2 = Medium temperature
 1 SLH-5G 2000
 2 SLH-5G 3000
 3 SLH-5G 4000

2. Determine peak height change of the motor.



Permissible deviations and dimensions: Manufacturer's specifications (→ Operating manual motor).

3. Calculate the difference between the two values determined (pump, motor).

Axial and angular offset alignment tolerances

For the purpose of alignment, the lowest value of the determined alignment tolerances (pump, coupling, motor) applies.

Radial offset alignment tolerances

The permissible radial offset results from the difference of the peak height change (pump, motor) plus the lowest value of the determined alignment tolerances (pump, coupling, motor).

Aligning the coupling

1. ➤ Measure the circumference of the coupling on two levels, each offset 90°.
2. ➤ Check the gap to the outer diameter with a straight-edge (no. 1 in Fig. 19):
 - Place straight-edge over both coupling halves.
 - In case of a gap to the outer diameter, align the motor (➔ 'Aligning the motor' on page 41).

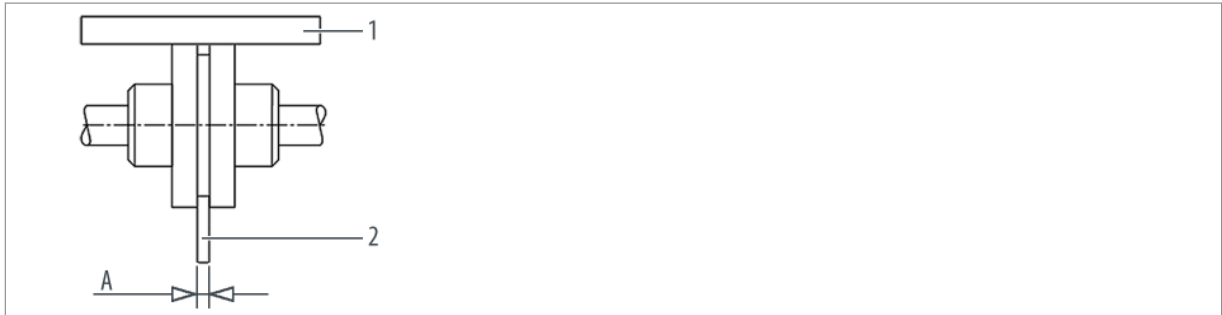

Fig. 19: Checking the coupling alignment

3. ➤ Check gap dimension with a feeler gauge (no. 2 in Fig. 19):
 - Permissible gap dimension: Manufacturer's specifications (➔ Operating manual coupling).
 - Measure gap dimension (A in ➔ 'Aligning the motor' on page 41) between the coupling halves with feeler gauge.
 - In the event of an impermissible gap dimension: Align the motor (➔ 'Aligning the motor' on page 41).
4. ➤ Check the lateral and height offset using a dial gauge:
 - Carry out measurement as shown (Fig. 20).
 - In the event of a lateral or height offset: Align the motor (➔ 'Aligning the motor' on page 41).

Permissible axial or radial deviation, measured on the front face of the coupling or at the coupling circumference: Observe the manufacturer's specifications for the pump, coupling and motor.

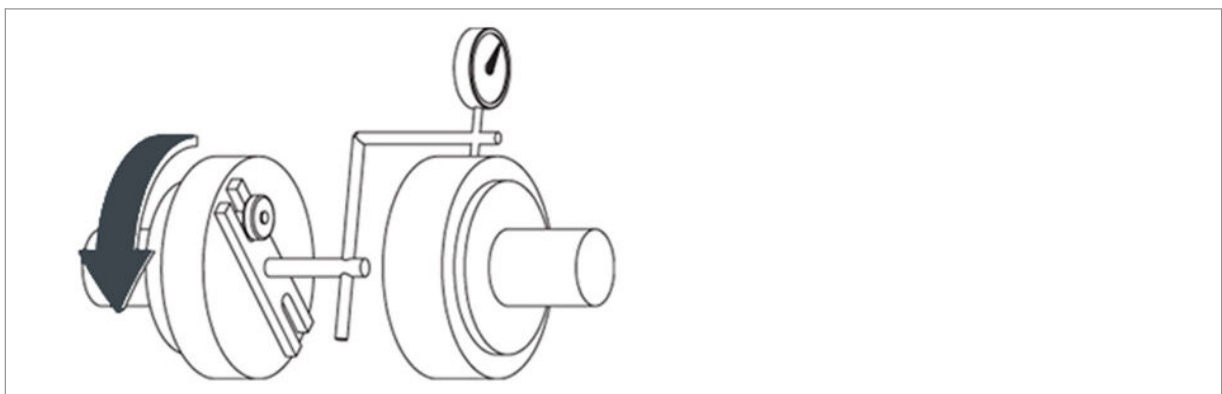



Fig. 20: Checking the lateral and height offset

5.  Check the angular offset with a dial gauge:
 - Carry out measurement as shown (Fig. 21).
 - In the event of an angular offset: Align the motor (→ 'Aligning the motor' on page 41).

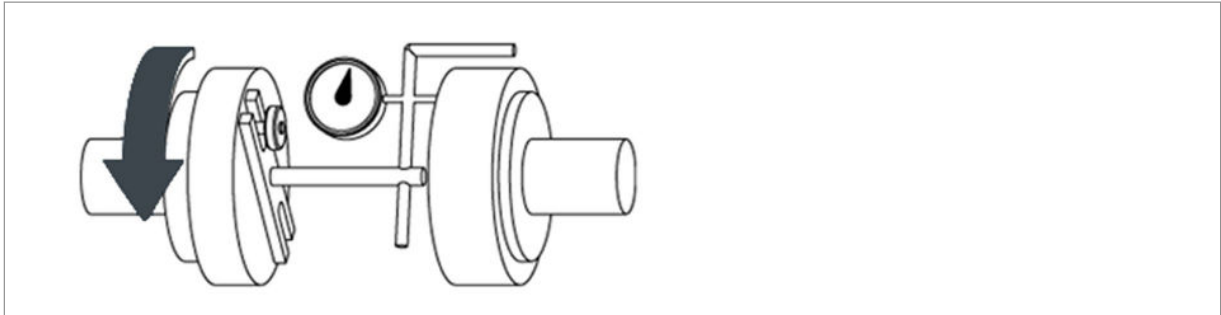



Fig. 21: Checking the angular offset

6.  Check the coupling alignment again and correct the motor alignment if necessary.







Aligning the motor





Application scenarios for a motor alignment

In the following cases a motor alignment is necessary:

- gap dimension too small/too large
- lateral, height or angular offset too small/too large

1.  Align the motor such that the coupling halves are precisely flush, if necessary position shim plates under the motor.
2.  Check alignment.
3.  If the height offset is still evident: repeat the alignment process.
4.  Then tighten screws for fastening the pump and motor.
5.  Check alignment again.
6.  If the height offset is still evident: Repeat the alignment process again.

6.5 Fitting the coupling guard

1.  If the coupling guard is not supplied fully fitted:
 - Fit the coupling guard.
 - Adjust the coupling guard to the distance between the pump and motor. In order to do so slide the slide piece into the outer part of the coupling guard.
 - Bolt together the outer part and the slide piece in such a way that contact with the coupling with fingers is no longer possible.
2.  If a protective hood is used:
 - Ensure space between the protective hood and pump/motor for ventilating the pump assembly.
 - Design and fasten the protective hood in such a way that contact with the coupling with fingers is not possible.





6.6 Configuring the pipelines

NOTICE

Property damage due to excessively high forces and torques of the piping on the pump!

To avoid damaging the pump, do not exceed permissible values (→ dimensional drawings).



If present: Observe instructions of the supply system manufacturer (e. g. sealing system supply).

1.  Calculate pipework forces and observe all operating statuses:
 - Cold/warm
 - Empty/full
 - Pressure-free/pressurised
 - Position changes of flanges
2.  Ensure that no additional static loads (e. g. wind load, snow load) have an effect on the pump.
3.  Ensure that pipe supports are constantly able to slide and do not rust and seize.
4.  Incorporate inlet and outlet-side venting.

Determining nominal widths



Keep the flow resistance in the pipework as low as possible.

1.  Establish the nominal diameter of the inlet line \geq the nominal diameter of the inlet nozzle.
2.  Establish the nominal diameter of the outlet line \geq the nominal diameter of the outlet nozzle.

Determining pipeline lengths

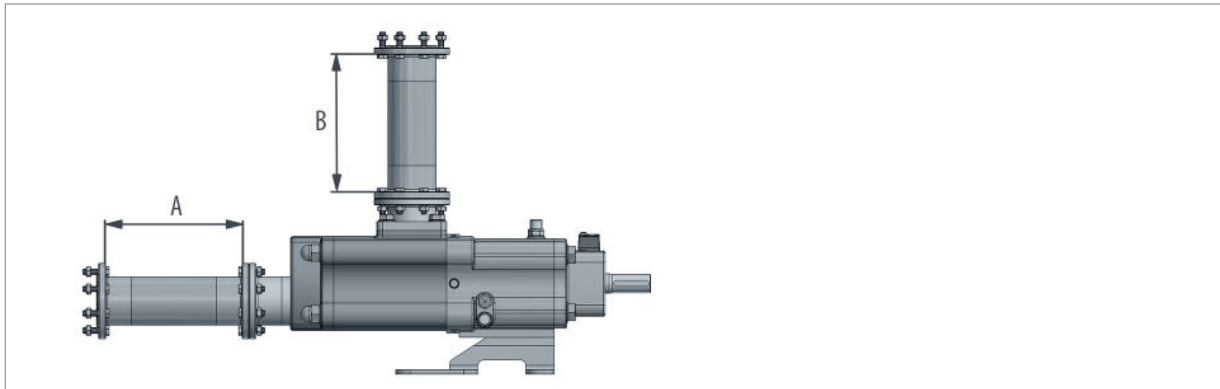

Fig. 22: Use straight lengths of pipe upstream and downstream of the pump (recommendation)

➔ Maintain recommended minimum values for installation of the pump:

- $A > 5 \times DN$
- $B > 5 \times DN$

DN = diameter nominal width



Inlet side: shorter lengths are possible, however, doing so may restrict the hydraulic performance data.

Outlet side: shorter lengths are possible, however, doing so may lead to increased noise.

Optimising changes in diameter and direction

To optimise changes in diameter and direction, proceed as follows:

1. ➔ Avoid sudden changes in diameter and direction in the pipe course.
2. ➔ Ensure that no cavitation occurs.
3. ➔ Account for thermal expansion.

Combination of the operator side lines

! NOTICE

Impairment of operation due to incorrect design of the lines!

- For further information on the design of the lines, contact the manufacturer (ITT Bornemann GmbH).





The design of the pipelines can significantly influence the operating behaviour of the pump.

The following factors are relevant:

- Pipe dimensions,
- Course of the lines,
- Arrangement of the pipe branches.

Avoiding overpressure

In order to avoid overpressure, the following conditions must be ensured:

1.  Ensure that the factory setting of the safety device complies with the pump requirements.
2.  Always guide the safety device return into the safe (pressureless) area.
3.  To exclude impermissible pressure build-up, monitor pressure build-up.
4.  Ensure that the pressure level in the safe area guarantees pressure relief via the safety device.

Provide filter in the inlet line

NOTICE

Pump damage due to unsuitable filter insert!

The use of an unsuitable filter insert can affect the pumping capacity of the pump and may lead to cavitation and damage to the pump.

- Only operate the system with a suitable filter insert.
- During commissioning or after maintenance work on the pipeline network, a fine filter insert is required.
- The fine filter insert must be removed during operation.



A filter in the inlet line is also recommended during ongoing operation.

Depending on the application, filtering of highly viscous conveyance fluids may not be possible for process reasons. In these cases, alternative protective provisions must be implemented, e. g. safe cleaning of the pipelines on the inlet side before commissioning by the operator.

1.  Provide a filter in the inlet line and select the mesh size for the filter insert according to the following table:

Tab. 11: Mesh size for the filter insert

Operating phase	SLH-5G Size	Mesh side [mm] depending on the viscosity of the medium to be pumped	
		Viscosity: 1 -600 mm ² /s	Viscosity: > 600 mm ² /s
Start-up phase during commissioning	all sizes	1	1
Start-up phase after maintenance work on the pipeline network, etc.			
Ongoing operation	2000	2	3
	3000	4	6
	4000	4	6

2.  In order to monitor the contamination include differential pressure monitoring:
 - Observe permissible differential pressure of the filter (→ manufacturer's instructions)

Avoiding running in reverse

1. → With a safety-related component (non-return protection), make sure that the medium cannot flow back after switching off the pump.

! NOTICE

Property damage resulting from pump reversal!

- Do not operate the pump without non-return protection!

2. → Select a distance < 2 m between the outlet nozzle and the non-return protection.

6.7 Connecting the pipelines

! NOTICE

Damage to the pump due to loose residues in the pipework!

Welding slag or weld beads and other loose objects may damage the pump.

- Remove loose residues from the pipework.

Prerequisites:

- All pipelines, sliders and valves are thoroughly cleaned and flushed.
- Pump and drive are aligned (→ Chapter 6.4 'Aligning the pump assembly' on page 36).
- Pipelines are closed and secured by sliders.

1. → Prior to assembly, clean all pipe sections and valves.
2. → Remove blank flanges, plugs, protective film and/or protective paint on sealing surfaces of flanges.

Install supply lines





To avoid air pocket formation: Always lay lines such that these rise or fall towards the pump.

- Install supply lines (e. g. for sealing supply system) strain-free and leak-tight.



Installing the inlet line

1. → Remove transport closures.
2. → Install the operator side inlet line so it is tension-free and leak-tight.

Installing the outlet line

1.  Remove transport closures.
2.  Install the operator side outlet line so it is tension-free and leak-tight.

If provided: Install additional lines on the operator's side

1.  Remove transport closures.
2.  Install operator side lines.



Guiding operator side pipelines to the safe area

All valves or pipe ends, from which medium can escape into the atmosphere, must be guided to the safe area.

These include e. g.:





- Blow down valve and blow down piping,
- Pressure safety valve and pressure safety piping,
- Ventilation valve and ventilation line,
- Drain valves and drainage lines.

Installing the heating line (if provided)

1.  Remove transport closures.
2.  Install the fittings.
3.  Install the heating line.

Check that the pipeline connection is tension free

Before the check, the following prerequisite must be fulfilled:

- The pipelines are correctly laid and cooled.
1.  Disconnect the pipeline connection flanges from the pump.
 2.  Check that the pipe can be moved freely in all directions in the vicinity of anticipated expansion:
 - Nominal diameters of less than 150 mm: by hand,
 - Nominal diameters of more than 150 mm: with a small lever.
 3.  Ensure that the flanges lie plane parallel.
 4.  Fasten the connection flanges of the pipelines to the pump system again, observing the admissible flange loadings (→ dimensional drawing).

Checking the flange connections

Check all flange connections again and tighten if necessary. Tightness test required.

6.8 Electrical connection

Earthing the pump assembly

- ➔ Earth the pump assembly at the connections provided for this purpose. The earthing connections are marked with the earthing symbol (Fig. 23).

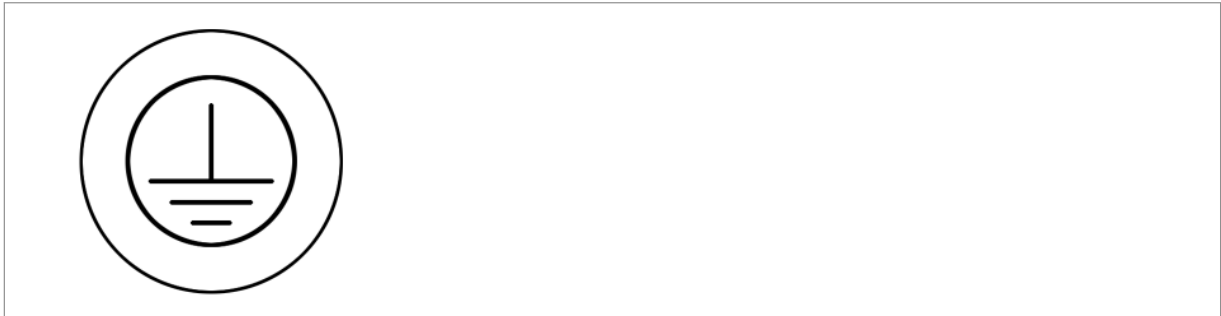

Fig. 23: Earthing symbol

Connect supply systems (e. g. sealing supply system)

- ➔ Connect the power lines according to the circuit diagram.

Connect the motor

- ➔ Connect the power lines according to the circuit diagram.

Check the direction of rotation



If present: Use a rotary field meter to check the direction of rotation.

! NOTICE

Property damage due to dry running and incorrect direction of rotation!

- Disconnect the motor from the pump.

- ➔ Switch the motor on and immediately switch it off again.
- ➔ Check that the motor's direction of rotation matches the direction of the arrow on the pump.
- ➔ In the event of deviating direction of rotation:
 - Swap the two phases.
- ➔ Re-couple the motor.

7 Commissioning



This chapter contains information on commissioning the pump. This information applies to both initial commissioning and recommissioning, for example after maintenance and repair work.

Personnel:

- Supervisor
- Qualified mechanic
- Qualified electrician

Protective equipment:

- Protective work clothing
- Safety shoes
- Safety goggles
- Hearing protection
- Protective gloves

7.1 Prepare the pump

Removing the preservative



If the pump was previously preserved: Remove preservative (⇒ Chapter 5.3 'Removing the preservative' on page 30).

Check lubrication

- ➔ Check the oil level at the oil sight glass (Fig. 25) and top up lubricating oil if necessary (⇒ Chapter 9.3.3 'Refilling the lubricating oil' on page 60).

Prepare heating system (if provided)

1. ➔ Install the pump heating components according to manufacturer's specifications.
2. ➔ Put the heating/cooling components into operation according to manufacturer's specifications and take the following points into account:
 - Ensure a temperature difference between the heating medium and the pumped medium of < 50 K.
 - Switch on heating at least 2 hours before commissioning the pump.
 - It is possible that the centre height of the drive shaft may change as a result of heating up. In this case, the pump assembly must be realigned (⇒ Chapter 6.4 'Aligning the pump assembly' on page 36).

Flush pump and pipelines with water

During initial commissioning and before recommissioning after maintenance and repair work such as dismantling the pump and/or piping:

- Flush pump and pipelines with water.

7.2 Prepare sealing supply system (if provided)

1. → For further information: Observe the documentation from the manufacturer of the seal supply system as well as the Operating & Installation Diagram.

2. →



The barrier fluid must be compatible with the conveyed medium!

Put sealing supply systems into operation according to manufacturer's specifications.

3. → If the sealing supply system has a circulation pump: Switch on circulation pump at least 5 minutes before commissioning the pump.

7.3 Fill and bleed pump

! NOTICE

Property damage due to dry running!

Dry running can cause damage to the pump, including total failure.

- Ensure that the pump is filled with liquid medium before switching on.









Filling the pump with pumped medium via an inlet side shut-off valve (to be provided by the operator) is described below.

Alternatively, the pump can also be filled via a suitable connection for filling in the inlet line. The medium used for filling must be compatible with the pumped medium. Steps 3 and 4 of the following procedure are then to be implemented accordingly via the connection for filling.









The following prerequisites for filling must be fulfilled:

- The system is correctly installed and connected (→ Chapter 6 'Set-up and connection' on page 31)
- All pipeline connections sealed leak-tight and tension-free.
- The system is fully shut down and pressure-free.
- The system is secured against being switched back on (→ Chapter 2.10 'Securing against restarting' on page 19).
- If present: Filter with corresponding filter insert installed in the inlet line for commissioning (→ 'Provide filter in the inlet line' on page 44).

1. → If present: Ensure that the drain line is closed through suitable fittings.

2.  If no suitable valve for venting (venting valve) is present:
 - Install a suitable venting valve on the outlet side blank flange or at an as high as possible point of the system and lead it into the safe area.
3.  Open inlet side shut-off valve or alternative.
4.  Wait until pressure equalisation has taken place and close the inlet side shut-off valve or alternative once more.
5.  Open the venting valve in order to vent the pump and pipelines.
6.  Close the venting valve again.
7.  Repeat filling procedure (steps 3-6) until the pump has been completely filled with liquid medium.
8.  Ensure that all of the connections and connecting pieces are leak-tight.

7.4 Switching on at commissioning

1.  Ensure that the pump has been properly filled and vented (→ Chapter 7.3 'Fill and bleed pump' on page 49).
2.  Ensure that all safety devices are functional and properly installed or fastened (→ Chapter 2.9 'Safety equipment' on page 18).
3.  Ensure that the pumped medium is at the operating temperature (→ data sheet).
4.  If present: Fully open the outlet side valve.
5.  If present: Fully open the inlet side valve.
6.  Switch on the motor and ensure that it runs smoothly.
7.  In the event of hot pumped medium: Ensure temperature change of less than 2 K/min.
8.  After reaching operating temperature: Stop the pump briefly and check alignment.
9.  After initial operation under pressure at operating temperature: check that the pump is leak-tight.

8 Operation



This chapter contains information on the normal operation of the pump and provisions to be implemented depending on the pumped medium during interruptions in operation.

Personnel:

- Supervisor
- Qualified mechanic
- Qualified electrician

Protective equipment:

- Protective work clothing
- Safety shoes
- Safety goggles
- Hearing protection
- Protective gloves

8.1 Starting operation

1. Ensure that the commissioning of the pump has been properly performed (→ Chapter 7 'Commissioning' on page 48).
2. If present: For the filter in the inlet line (to be provided by the operator), change the filter insert for the ongoing operation (→ 'Provide filter in the inlet line' on page 44).
3. With heating: Switch on pump heating at least 2 hours before pump operation.
4. Ensure that the pumped medium is at the operating temperature (→ data sheet).
5. If present: Switch on the sealing supply system according to the manufacturer's instructions (→ documentation from the sealing supply system manufacturer).
6. Fully open the outlet side valve.
7. Fully open the inlet side valve.
8. Switch on the motor and ensure that it runs smoothly.
9. In the event of hot pumped medium: Ensure temperature change of less than 2 K/min.

8.2 Stopping operation

1. Switch off the motor.
2. Close the inlet side valve.
3. Close the outlet side valve.
4. If a sealing supply system is available: Wait until 2 minutes have elapsed since switching off the motor (step 1) and switch off the sealing supply system according to the manufacturer's instructions (→ documentation from the sealing supply system manufacturer).
5. If present and permitted in the process (solidifying of pumped medium must be prevented!): Switch off heating.

6. → Observe provisions in the event of operational interruption (⇒ Chapter 8.4 'Provisions in the event of operational interruptions' on page 54).

8.3 Cleaning/sterilising the pump



- Pumps of the SLH-5G series can be cleaned/sterilised without dismantling.
- According to DIN EN 13951, the pump corresponds to cleanability grade 4.

! NOTICE

Damage to pump, hoses and fittings with pressure testing or rinsing!

- When carrying out pressure tests or rinsing:
 - Do not expose pump, hoses or fittings to impermissible pressure.
 - Disconnect pump, hoses or fittings from the system in advance if necessary.

! NOTICE

Property damage due to impermissible temperature shocks!

- Temperature shocks > 50 K are not permitted.
In this case, heating must take place gradually, whereby a maximum temperature gradient of $\Delta T_{\max} = 10 \text{ K/min}$ must not be exceeded.

8.3.1 Cleaning/sterilising with CIP/SIP medium < 80 °C

Prerequisites:

- For pumps with sealing supply system: Sealing supply system in operation.
- Pump stopped.

1. →



The CIP/SIP medium must be compatible with the material!

Switch pipeline system to CIP/SIP medium.

2. → Start pump.
3. → Clean pipeline system and pump.
4. → Stop pump.
5. → Remove all traces of the CIP/SIP medium.

8.3.2 Cleaning/sterilising with CIP/SIP medium > 80 °C and pump with sealing supply system

Prerequisites:

- Sealing supply system in operation.
- Pump stopped.

1. →



The CIP/SIP medium must be compatible with the material!

Switch pipeline system to CIP/SIP medium.

2. →

Start pump and observe the following when pump is cold:

- Stop the pump for approx. 10 minutes shortly after starting.
- Wait for casing temperature above 60 °C.
- Restart the pump.

3. →

Clean/sterilise pipeline system and pump.

4. →

Stop pump.

5. →

Remove all traces of the CIP/SIP medium.

8.3.3 Cleaning/sterilising with CIP/SIP medium > 80 °C and pump without sealing supply system

Prerequisite:

- Pump stopped.

! NOTICE

Material damage due to overheated mechanical seal!

- Only clean/sterilise pump when it is stopped.
- Cleaning time shorter than 30 minutes.

! NOTICE

Material damage due to turbine effect!

- During cleaning/sterilising due to steaming: Lock pump.

1. →



The CIP/SIP medium must be compatible with the material!

Switch pipeline system to CIP/SIP medium.

2. →

Clean/sterilise pipeline system and pump.

Operation

Operating the pump as a stand-by pump

- 3. ➤ Remove all traces of the CIP/SIP medium.
- 4. ➤ Remove the blockage.

8.4 Provisions in the event of operational interruptions

➤ Carry out provisions depending on the pumped medium and the duration of the operating interruption according to the following table:

Tab. 12: Provisions in the event of operational interruptions

Pumped medium behaviour	Provisions depending on the duration of the operational interruption (process-dependent)	
	short (Guideline value: maximum 1 week)	long
Sludge solids	1. Empty pump and pipelines (↔ Chapter 11.1 'Emptying' on page 68). 2. Clean pump and pipelines (↔ Chapter 8.3 'Cleaning/sterilising the pump' on page 52).	1. Empty pump and pipelines (↔ Chapter 11.1 'Emptying' on page 68). 2. Clean pump and pipelines (↔ Chapter 8.3 'Cleaning/sterilising the pump' on page 52).
solidified/frozen	Heat or empty pump and pipelines (↔ Chapter 11.1 'Emptying' on page 68).	1. Empty pump and pipelines (↔ Chapter 11.1 'Emptying' on page 68). 2. Clean pump and pipelines (↔ Chapter 8.3 'Cleaning/sterilising the pump' on page 52).
remains liquid	-	1. Empty pump and pipelines (↔ Chapter 11.1 'Emptying' on page 68). 2. Clean pump and pipelines (↔ Chapter 8.3 'Cleaning/sterilising the pump' on page 52).

8.5 Operating the pump as a stand-by pump



Parallel operation of pumps only with express approval of ITT Bornemann GmbH.

- Alternately operate the pump and stand-by pump:
 - Operate the stand-by pump at least once per week.

8.6 Winter operation

WARNING

Risk of injury due to frost!

In case of frost, contact with metallic components leads to injuries due to freezing.

- Wear personal protective equipment, in particular suitable protective gloves.
- Avoid unnecessary contact with components.

NOTICE

Property damage due to frost!

If the system is switched off, the remaining medium in the components may freeze and cause them to burst at low temperatures.

- Ensure that the components are drained and depressurised.
- Ensure that the system has been put out of operation properly (→ Chapter 11 'Putting out of operation' on page 68).

9 Servicing



This chapter contains information on servicing the pump, as well as ordering spare parts. It also describes how the pump can be removed and sent to the manufacturer for repair.

For information on servicing other components: Observe the documentation from the manufacturer of the respective component.

Personnel:

- Supervisor
- Qualified mechanic
- Qualified electrician

Protective equipment:

- Protective work clothing
- Safety shoes
- Industrial safety helmet
- Safety goggles
- Hearing protection
- Protective gloves

9.1 Monitoring

1. → For trouble-free operation, monitor and ensure:

- No deposits of greater than 5 mm on surfaces (clean surfaces regularly!)
- valves open on inlet and outlet side (if present)
- free and clean filter in the pipelines (if present)
- clear and clean ventilation filter in bearing casing
- Sufficient supply pressure
- No impermissible leakage at the mechanical seal
- proper functioning of the sealing supply system (if present) as well as sufficient barrier medium and barrier pressure
- Proper function of the safety equipment
- No dry run
- No cavitation
- Tightness
- No unusual running noises or vibrations
- No rigid body vibrations, e. g. via the foundation or pipeline connections, which influence the pump

2. → Check at suitable intervals:

The test intervals are dependent on the pump loads.

- Alignment of the coupling and condition of the elastic elements
- Temperature of rolling bearings (alarm at 100 °C, shutdown at 120 °C)
- Sealing supply system and condition of the barrier fluid (if present)
- All warning and information signs present and legible

3. → To prevent danger due to unexpected corrosion:

- Inspect components that are in contact with the transport medium for unexpected detectable corrosion (e. g. pitting corrosion, surface corrosion).

In case of visible corrosion: Decommission the pump correctly (→ Chapter 11 'Putting out of operation' on page 68) and contact ITT Bornemann GmbH.

- In case of corresponding suitable disassembly work (e. g. while changing mechanical seals, changing conveying elements): Inspect shafts and conveying elements for corrosion.

In case of visible corrosion: Do not commission the pump again, contact ITT Bornemann GmbH.

9.2 Maintenance schedule



Maintenance intervals are shorter with more severe operating conditions (e. g. frequent switching on/off, high temperatures, low viscosity, aggressive environmental and process conditions).

Performing maintenance work

1. → Before all maintenance work: Ensure that there is no danger to persons or the environment.

This depends on the type of maintenance work to be carried out:

- Switch the drive system off and secure it to prevent a restart/being switched on again (→ Chapter 2.10 'Securing against restarting' on page 19).
- Securely close all interfaces to the pumping process.
- Relieve the pressure from the pump and the operator's piping into the safe area and secure against renewed pressurisation.
- Empty the pump and operator-side piping into the safe area (→ Chapter 11.1 'Emptying' on page 68) and clean (→ Chapter 8.3 'Cleaning/sterilising the pump' on page 52).

2. → Unless otherwise necessary due to the operating mode, carry out maintenance work in accordance with the following table:

Tab. 13: Maintenance – general intervals and provisions

Interval	Assembly	Provision
Once, after reaching operating temperature for the first time	Pump, coupling, motor	<ul style="list-style-type: none"> ■ Check hot alignment (→ Chapter 6.4 'Aligning the pump assembly' on page 36).
Hourly, during start-up phase	Sealing supply system (if present)	<ul style="list-style-type: none"> ■ Check filling level of barrier fluid.¹⁾ ■ Check filter and ventilation valve for contamination.¹⁾
Weekly	Bearing casing	<ul style="list-style-type: none"> ■ Check oil level. <ul style="list-style-type: none"> – Only at a standstill (wait approx. 15 min) ■ Top up/replace oil if necessary (→ Chapter 9.3.3 'Refilling the lubricating oil' on page 60 / → Chapter 9.3.4 'Changing the lubricating oil' on page 61)
	Mechanical seal	<ul style="list-style-type: none"> ■ Check for leakage. ■ In the event of severe leakage: <ul style="list-style-type: none"> – Determine leakage intensity by counting the drops. – Consult with ITT Bornemann GmbH (specify leakage site and intensity). – Replace mechanical seal (consult with ITT Bornemann GmbH).
	Lip seals	<ul style="list-style-type: none"> ■ Check for leakage. ■ In the event of severe leakage: <ul style="list-style-type: none"> – Check oil levels at short intervals. – Determine leakage intensity by counting the drops. – Consult with ITT Bornemann GmbH (specify leakage site and intensity). – Replace lip seal (consult with ITT Bornemann GmbH).
	Drive unit	<ul style="list-style-type: none"> ■ Check for wear.
	Sealing supply system (if present)	<ul style="list-style-type: none"> ■ Check function.¹⁾ ■ Clean filter and ventilation valve.¹⁾ ■ Top up barrier fluid if necessary.¹⁾ ■ If barrier fluid is contaminated: <ul style="list-style-type: none"> – Check mechanical seal.
	Heating system (if present)	<ul style="list-style-type: none"> ■ Check function.¹⁾ ■ Check tightness.¹⁾
	Once after the first 250 hours of operation, at the latest after 3 months	Sealing supply system (if present)
once after 3 months	Coupling	Service the coupling in accordance with the manufacturer's instructions (→ Operating manual coupling).
	Motor	Service the motor in accordance with the manufacturer's instructions (→ Operating manual motor).
After 4000 hours of operation, at the latest after 12 months	Sealing supply system (if present)	Change barrier fluid. ¹⁾

Interval	Assembly	Provision
Annually	Coupling This maintenance interval can be shortened depending on the coupling type. ¹⁾	Service the coupling in accordance with the manufacturer's instructions (→ Operating manual coupling).
	Motor This maintenance interval can be shortened depending on the motor type. ¹⁾	Service the motor in accordance with the manufacturer's instructions (→ Operating manual motor).

¹⁾ Observe the manufacturer's instructions!

Tab. 14: Maintenance – Oil lubrication maintenance intervals

Application	Interval	Assembly	Provisions (to be performed by specialist personnel)
<ul style="list-style-type: none"> ■ Area: Foods & pharmaceuticals ■ Ambient temperature: -40 °C to ≤ 40 °C ■ PAO oil 	<p>Oil lubrication:</p> <ul style="list-style-type: none"> ■ After the first 250 hours of operation, at the latest after 3 months ■ intermittent operation: every 4000 hours of operation, at the latest after 24 months ■ continuous operation: every 8000 hours of operation, at the latest after 18 months 	Gears and bearings	<ul style="list-style-type: none"> ■ Change oil (→ Chapter 9.3.4 'Changing the lubricating oil' on page 61).

9.3 Lubrication



The lubricant used for first filling is noted on a material label on the pump.

! NOTICE

Property damage resulting from the use of incompatible lubricants!

- Only use one type of lubricant!

! NOTICE

Property damage due to incorrect lubrication!

- Ensure correct type of lubricant (→ Supplementary document on lubricants and preservatives).
- Ensure sufficient lubricant quantity (→ Chapter 9.3.2 'Lubricant quantity' on page 60).

9.3.1 Lubrication points

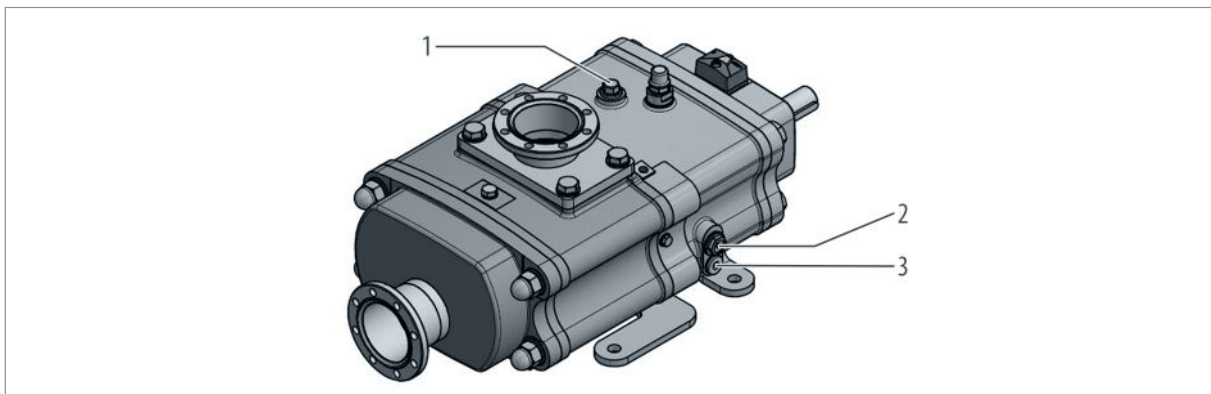

Fig. 24: Overview with lubrication points (oil lubrication)

- 1 Oil inlet
- 2 Oil sight glass
- 3 Oil drain

9.3.2 Lubricant quantity

Tab. 15: Lubricant quantities — Lubricating oil

SLH-5G Size	Bearing casing approx. oil quantity [l]
2000	0.60
3000	1.20
4000	2.40

9.3.3 Refilling the lubricating oil



The lubricant used for first filling is noted on a material label on the pump.

! NOTICE

Property damage resulting from the use of incompatible lubricants!

- Only use one type of lubricant!

1. Switch off pump and safeguard against a restart.
2. Let pump cool down (at least 15 minutes).
3. Open the oil inlet.

4. ➔ Fill bearing casing with lubricating oil until the oil level in the oil sight glass is within the specified limits (Fig. 25).

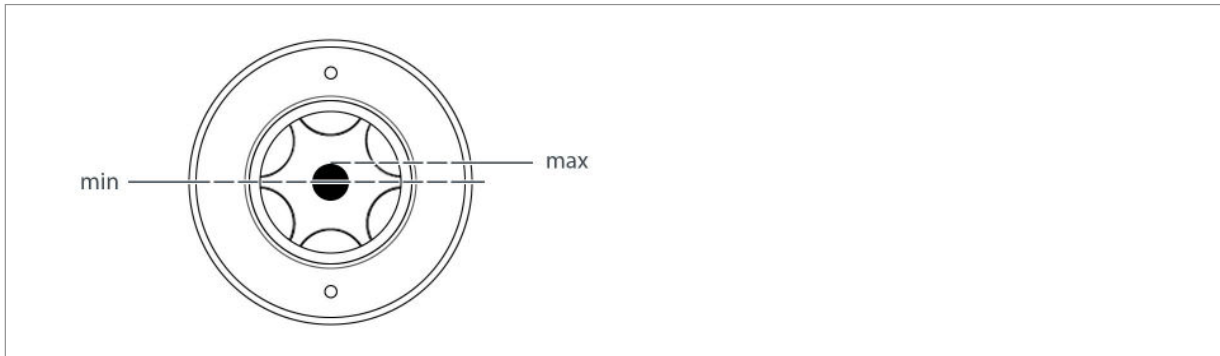

Fig. 25: Oil sight glass on bearing casing

max Maximum oil level
min Minimum oil level

5. ➔ Close the oil inlet.

9.3.4 Changing the lubricating oil

1. ➔ Switch off pump and safeguard against a restart.
2. ➔ Let pump cool down (at least 15 minutes).
3. ➔ Open the oil drain and drain the lubricating oil at operating temperature into a suitable collection container. The collecting container must be able to collect the following quantities of lubricating oil:

Tab. 16: Lubricating oil quantities

SLH-5G Size	Bearing casing approx. oil quantity [l]
2000	0.60
3000	1.20
4000	2.40

4. ➔ Close oil drain again and top up lubricating oil (➔ Chapter 9.3.3 'Refilling the lubricating oil' on page 60, start with step 3).

9.4 Repairs



Warranty claims shall be void in the event that the pump is opened by an unauthorised person during the warranty period. The pump may only be opened by trained technicians from ITT Bornemann GmbH.

Trained customer service technicians from ITT Bornemann GmbH are available for repairs. Upon request, present verification for the pumped material – DIN safety data sheet or declaration of no objection (➔ Appendix 'Declaration of no objection' on page 78).

9.4.1 Wearing parts



Wearing parts have a limited shelf-life because of their functionality and are therefore not subject to the warranty.

Regarded as standard wearing parts are:

- Mechanical seals
- Gaskets
- Roller bearing
- Lip seals
- O-rings

Regarded as long-term wearing parts are:

- Feed screw
- Pump casing



Mechanical seals are subject to natural wear, which largely depends on the respective conditions of use. It is therefore not possible to provide general information regarding the service life.

9.4.2 Ordering spare parts



*Only use original parts or parts approved by ITT Bornemann GmbH.
Spare parts lists can be requested of ITT Bornemann GmbH if desired.*

1. ➔ The following information is required for ordering spare parts (Fig. 2):









- Pump type
- Order number
- Serial number
- Position number of the part (→ spare parts list)
- Name of the part (→ spare parts list)
- Quantity

2. ➔ Specify internal clearance when ordering bearings:

Tab. 17: Bearing clearance of the roller bearings

Roller bearing	internal clearance
Cylindrical roller bearing	Normal air
single-row angular contact ball bearing	Normal air

9.4.3 Removing the pump



1.  Decommission the pump correctly (⇒ Chapter 11 'Putting out of operation' on page 68).
2.  Make sure that the power supply to the drive system is switched off and secured to prevent it from being switched back on.
3.  Make sure that all interfaces for the pumping process are securely closed.
4.  Ensure that pump and pipelines have been de-pressurised properly and secured to prevent re-pressurisation.
5.  Ensure that the pump has cooled down.
6.  For coupling with spacer: Remove the spacer.
7.  Safely disconnect all connections from the pump.
8.  Drain lubricating oil from the bearing casing and collect it safely.
9.  Remove the pump.

9.4.4 Sending the pump to the manufacturer





Repair work may only be executed if the declaration of no objection has been received (⇒ Appendix 'Declaration of no objection' on page 78).

Prepare the pump for transport:

1.  Disassemble the pump correctly (⇒ Chapter 9.4.3 'Removing the pump' on page 63).
2.  Clean the pump.
3.  Seal off the inlet and outlet sides with plastic covers.

Ship the pump:

1.  Only send the pump to ITT Bornemann GmbH with a truthful and fully completed declaration of no objection (⇒ Appendix 'Declaration of no objection' on page 78).
2.  Depending on the desired repair, observe the required provisions for return in accordance with the following table.

Tab. 18: Repair and return

Repair	Provisions for return
To be performed by ITT Bornemann GmbH	<ul style="list-style-type: none"> ■ Return complete pump (not disassembled) to ITT Bornemann GmbH. ■ Specify the following details: <ul style="list-style-type: none"> – Reason for repair – Operating conditions
With warranty claim via ITT Bornemann GmbH	<ul style="list-style-type: none"> ■ Return complete pump (not disassembled) to ITT Bornemann GmbH. ■ Specify the following details: <ul style="list-style-type: none"> – Information about occurrence of damage – Operating conditions

9.5 Cleaning agent



The cleaning agent must be compatible with the material!

Only use cleaners that are permitted for hygiene-protected areas.

10 Troubleshooting



This chapter provides information on possible pump faults, their causes and on provisions through which to rectify the faults.

For information on troubleshooting on other components: Observe the documentation from the manufacturer of the respective component.

Behaviour during faults

The following always applies:

1. → Immediately initiate an EMERGENCY STOP in the event of faults that present an immediate danger to persons or property.
2. → Determine the cause of the fault (→ Tab. 20 'Fault table' on page 65).
3. → If fault rectification requires work in the danger area, switch off the system and secure it against being switched on again/restart (→ Chapter 2.10 'Securing against restarting' on page 19).
Immediately inform those responsible at the place of installation of the fault.
4. → Depending on the type of fault, have it rectified by authorised specialist personnel or repair it yourself.

Faults that are not specified in the following table or that are not traceable to one of the specified causes should be discussed with ITT Bornemann GmbH.

The possible faults are assigned a number in the following table. The number can then be used to determine the cause of the fault and the provisions to be implemented to rectify this with the aid of the fault table.

Tab. 19: Faults and assigned numbers

Fault	Number
Pump fails to convey	1
Pump conveys insufficiently	2
Pump conveys excessively	3
Pump runs unevenly or extremely loudly	4
Pump jams	5
Pump leaks	6
Power consumption of the motor too high	7

Tab. 20: Fault table

Number of the fault							Cause of the fault	Provisions for fault rectification
1	2	3	4	5	6	7		
X	X	-	-	-	-	-	Excessive clearance between: <ul style="list-style-type: none"> ■ Feed screws ■ Feed screws and casing 	<ul style="list-style-type: none"> ■ Repair or exchange worn parts. ■ Consult with ITT Bornemann GmbH.
X	-	-	X	-	-	-	Delivery/inlet line closed by valve.	<ul style="list-style-type: none"> ■ Fully open valves.

Number of the fault							Cause of the fault	Provisions for fault rectification
1	2	3	4	5	6	7		
X	-	-	X	-	-	-	Pump not sufficiently filled.	<ul style="list-style-type: none"> Fill the pump (→ Chapter 7.3 'Fill and bleed pump' on page 49).
X	X	-	X	-	-	-	Speed too low.	<ul style="list-style-type: none"> Increase speed with speed regulator.
X	X	-	X	-	-	-	Delivery/inlet line, pump or filter blocked or encrusted.	<ul style="list-style-type: none"> Clean delivery/inlet line, pump or filter. Check filter mesh size and change if necessary, in consultation with ITT Bornemann GmbH.
X	-	X	X	-	-	-	Pump direction of rotation incorrect.	<ul style="list-style-type: none"> Check and, if necessary, correct the direction of rotation of the motor (→ 'Check the direction of rotation' on page 47).
X	-	-	X	X	-	X	Pump contaminated.	<ul style="list-style-type: none"> Consult with ITT Bornemann GmbH.
X	X	-	X	.	.	X	Outlet line blocked.	<ul style="list-style-type: none"> Clean outlet line.
X	X	-	X	X	X	X	Connecting screws not properly tightened.	<ul style="list-style-type: none"> Tighten connecting screws.
X	X	X	X	X	X	X	Viscosity or temperature of the pumped medium deviates from the design data for the pump (→ data sheet).	<ul style="list-style-type: none"> Consult with ITT Bornemann GmbH.
-	X	-	X	-	-	-	Diameter of the inlet or outlet line too narrow.	<ul style="list-style-type: none"> Increase diameter. Clean inlet or outlet line of deposits.
-	X	-	X	-	-	-	Temperature of the conveyed medium too high: Pump cavitation.	<ul style="list-style-type: none"> Lower temperature. Adjust speed. Consult with ITT Bornemann GmbH.
-	X	-	X	-	-	X	Outlet side valve insufficiently opened.	<ul style="list-style-type: none"> Fully open the outlet side valve.
-	-	X	X	-	-	X	Speed too high.	<ul style="list-style-type: none"> Lower speed with speed regulator.
-	-	-	-	-	X	-	Pump leaking.	<ul style="list-style-type: none"> Consult with ITT Bornemann GmbH.
-	-	-	X	-	-	-	Coupling elements worn. Coupling not properly aligned.	<ul style="list-style-type: none"> Replace the coupling elements, check and, if necessary, correct the coupling alignment (→ 'Aligning the coupling' on page 40).
-	-	-	X	-	-	-	Insufficient oil in bearing casing.	<ul style="list-style-type: none"> Refilling the lubricating oil (→ Chapter 9.3.3 'Refilling the lubricating oil' on page 60).
-	-	-	X	X	-	-	Pipelines too tight.	<ul style="list-style-type: none"> Check pipeline. Connect pipelines so that they are slack.
-	-	-	X	X	-	X	Expansion of the internal pump components under excessive temperatures.	<ul style="list-style-type: none"> Wait for the temperature to equalise.
-	-	-	X	X	-	X	Bearings/gears faulty.	<ul style="list-style-type: none"> Consult with ITT Bornemann GmbH. If necessary, send pump to ITT Bornemann GmbH. (→ Chapter 9.4.4 'Sending the pump to the manufacturer' on page 63)

Number of the fault							Cause of the fault	Provisions for fault rectification
1	2	3	4	5	6	7		
-	-	-	X	X	-	X	Pump excessively tight.	<ul style="list-style-type: none"> ■ Check the connections and pipeline nozzles and fastenings on the pump. ■ Check the alignment of the coupling. ■ If present: Check the fastening of the support. ■ Check foundation.
-	-	-	X	X	-	X	Motor bearings faulty.	<ul style="list-style-type: none"> ■ Consult with the manufacturer of the motor.

11 Putting out of operation



This chapter contains information on decommissioning the pump. Decommissioning must be performed in the following situations:

- *in the event of interruptions in operation depending on the pumped medium → Chapter 8.4 'Provisions in the event of operational interruptions' on page 54*
- *before maintenance and servicing work*
- *before removing the pump from the plant*

After each decommissioning, recommissioning must be performed in accordance with → Chapter 7 'Commissioning' on page 48!

Personnel:

- Supervisor
- Qualified mechanic
- Qualified electrician

Protective equipment:

- Protective work clothing
- Safety shoes
- Safety goggles
- Hearing protection
- Protective gloves

11.1 Emptying

1. → Switch the drive system off and secure it to prevent a restart/being switched on again (→ Chapter 2.10 'Securing against restarting' on page 19).
2. → Make sure that all interfaces for the pumping process are securely closed.
3. → Relieve the pump and operator side pipelines of pressure in the safe area.

4. →



Always safely collect any pumped medium that leaks out and dispose of this in accordance with applicable local regulations!

Empty the pump and operator side pipelines completely in the safe area.

11.2 Clean

The following prerequisites for cleaning must be fulfilled:

- All interfaces for the pumping process are securely closed.
 - The system is completely emptied and pressure-free (→ Chapter 11.1 'Emptying' on page 68).
- Clean the pump in accordance with → Chapter 8.3 'Cleaning/sterilising the pump' on page 52.

12 Disposal



This chapter contains information on proper disposal. Ensure that the pump has been decommissioned properly prior to disposal (→ Chapter 11 'Putting out of operation' on page 68).

1. → Drain lubricating oil from the bearing casing and collect it safely.
2. → Thoroughly clean components and disassemble these in compliance with applicable local occupational safety and environmental protection regulations.



If necessary, enclose a declaration of no objection (→ Appendix 'Declaration of no objection' on page 78) with each disassembled component.

3. → Insofar as no return or disposal agreement has been concluded, disassembled components must be recycled (if necessary with a declaration of no objection):
 - Scrap metals.
 - Give plastic elements to recycling.
 - Dispose of remaining components in accordance with locally applicable regulations.

13 Index

A	
Align	
Base plate.....	35
Coupling.....	40
Machine feet.....	34
Motor.....	41
Motor with the pump.....	37
Peak height change.....	39
Aligning the base plate.....	35
Alignment tolerances	
Base plate.....	35
Pump.....	37
Ambient conditions.....	33
Angle offset.....	39
Axial offset.....	39
B	
Base.....	33
Behaviour during faults.....	65
Bleed.....	49
C	
Calotte feet (see machine feet).....	34
Changing the lubricating oil.....	61
Check the direction of rotation of the motor.....	47
Clean.....	52, 68
Cleanability.....	52
Cleaning agent.....	64
Commissioning.....	48
Configuring the pipelines	
Avoiding overpressure.....	44
Avoiding running in reverse.....	45
Change in cross-section.....	43
Change in direction.....	43
Nominal widths.....	42
Operator side lines.....	43
Pipework lengths.....	43
Provide filter.....	44
Connecting the pipelines.....	45
Heating line.....	46
Inlet line.....	45
Outlet line.....	46
Supply lines.....	45
Connection.....	31
Contact customer service.....	5
Copyright.....	4
Coupling.....	21
align.....	40
installation.....	32
Cross-section change of pipework.....	43
Customer service.....	5
D	
Dangers.....	16
Declaration of conformity.....	80
Declaration of incorporation.....	79
Declaration of no objection.....	78
Differential pressure monitoring.....	44
Dimensions.....	10
Direction change of pipework.....	43
Disassembling the pump.....	63
Disposal.....	69
E	
Earthing connection.....	47
Electrical connection.....	47
EMERGENCY STOP button.....	19
Emptying.....	68
Environmental protection.....	20
Erroneous use (see Improper use).....	12
F	
Fill.....	49
Filter.....	44
Fitting the coupling guard.....	41
Foreseeable misuse (see Improper use).....	12
Foundation.....	33
Frequency converter.....	22
G	
General safety instructions.....	16
Glossary see technical terms.....	4
H	
Hot alignment (see determining peak height changes).....	39
Hygiene regulations.....	13
I	
i-ALERT.....	22
Improper use.....	12
Initial commissioning (see Commissioning).....	48
Install supply lines.....	45
Installation	
Coupling.....	32
Coupling guard.....	41

Heat insulation.	31	Operation.	51
Heating line.	46	start.	51
Inlet line.	45	stop.	51
of motor on profile frame or base plate.	33	Operational interruptions.	54
of pump on profile frame or base plate.	32	Operator obligations.	13
Outlet line.	46	Operator side lines.	43
Supply lines.	45	Ordering spare parts.	62
Installation of the heat insulation.	31	P	
Installation options.	34	Peak height change.	39
Installing the heating line.	46	Personal protective equipment.	15
Installing the inlet line.	45	Personnel qualifications.	14
Installing the outlet line.	46	Pipeline connection free of tension.	46
L		Pipework lengths.	43
Lifting.	23	Pipework overpressure.	44
Lubricant quantity.	60	Preparing the installation site.	33
Lubrication.	59	Preservative.	28
Changing the lubricating oil.	61	Proper use.	12
Lubricant quantity.	60	Protective equipment.	15
Lubrication points.	60	Protective equipment (see safety equipment).	18
Oil sight glass.	60	Provisions	
Refilling the lubricating oil.	60	in the event of operational interruptions.	54
Lubrication points.	60	with faults.	65
M		Pump	
Machine feet.	34	clean.	52, 68
Maintenance schedule.	57	commissioning.	48
Measuring devices.	22	Dimensions and weight.	10
Mesh size of filter insert.	44	disassembly.	63
Monitoring.	56	disposal.	69
Motor.	22	earth.	47
Align.	41	emptying.	68
Align with the pump.	37	fill and bleed.	49
Check the direction of rotation.	47	flush with water.	49
electrical connection.	47	Heat insulation.	31
install on profile frame or base plate.	33	Heating system.	21, 48
N		install on profile frame or base plate.	32
Noise level.	77	lifting and transporting.	23
Nominal widths of pipework.	42	lubrication.	59
Non-return device.	45	maintenance.	57
Normal operation (see operation).	51	monitoring.	56
O		Oil drain.	60
Obligations of the operator.	13	Oil inlet.	60
Oil drain.	60	Oil sight glass.	60
Oil inlet.	60	Operate stand-by-pump.	54
Oil sight glass.	60	operation.	51
		Operational interruptions.	54
		Overview drawing.	9
		Preservation.	28
		putting out of operation.	68

Rectify faults.	65	Sterilise.	52
Removing the preservative.	30	Stop.	51
repairs.	61	Storage.	27
send in for repair.	63	Supervisor.	14
service.	56	Supplementary documents.	3
set-up and connection.	31	Supply systems	
Spare parts.	62	electrical connection.	47
sterilise.	52	Install supply lines.	45
Storage.	27	Switching on at commissioning.	50
Type plate.	10	T	
Wearing parts.	62	Technical documentation (see supplementary documents).	3
Winter operation.	55	Technical terms.	4
Pump assembly		Transmitter (see measuring devices).	22
align.	36	Transport specialist.	14
Coupling.	21	Transportation.	23
earth.	47	Troubleshooting.	65
Fasten.	36	Type plate.	10
lifting and transporting.	23	W	
Motor.	22	Warranty conditions.	5
Set-up.	34	Wearing parts.	62
set-up and connection.	31	Weight.	10
Pump heating system.	21, 48	Winter operation.	55
Putting out of operation.	68		
Q			
Qualified electrician.	14		
Qualified mechanic.	14		
R			
Radial offset.	39		
Recommissioning (see Commissioning).	48		
Refilling the lubricating oil.	60		
Removing the preservative.	30		
Repairing the pump.	61		
S			
Safety.	11		
Safety equipment.	18		
Safety instructions.	11		
Sealing supply system.	22		
electrical connection.	47		
Install supply lines.	45		
prepare.	49		
Securing against restarting.	19		
Servicing.	56		
Set-up.	31		
Stand-by pump.	54		
Start.	51		

Appendix

Noise level



Measurements carried out as per DIN 45635, Part 1. The emission values have been determined under reproducible conditions in accordance with DIN 45635, Part 24. The measurement is based on a single screw pump.

The specified sound levels are approximate values.

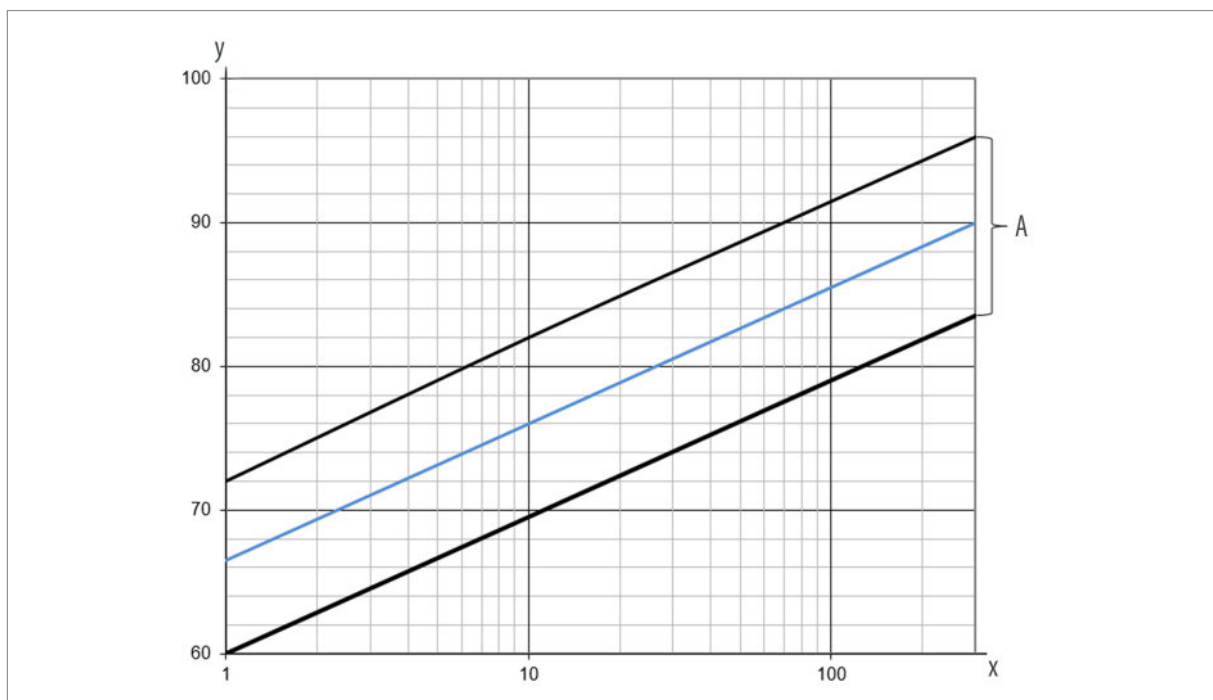

Fig. 26: Airborne sound level diagram (source: VDI 3734)

- x Output demand P [kW]
- y Sound level measurement surfaces LpA [dB]
- A Scatter band

Declaration of no objection

➤ Please copy, fill it out and send it with the pump.

Statutory regulations oblige all commercial companies to protect their employees, the public and the environment from the hazardous effects of dangerous substances.

For this reason, repair and inspection of the components may only be undertaken once the following declaration has been correctly and fully filled out and signed by an authorised, qualified specialist.

If safety measures must be employed despite complete emptying and cleaning on the part of the operator, then this required information must be passed on. This declaration of no objection comprises part of the repair or inspection order.

We hereby declare that the enclosed component

Type: _____

Serial number: _____

- is free of hazardous materials. Special safety measures for further handling of the device are not necessary.
- The device has been fully emptied and thoroughly cleaned inside and out prior to dispatch.

The following media was previously conveyed by the _____
pump:

The medium was hazardous: YES NO

The pump was emptied by the operating firm: YES NO

The pump was thoroughly cleaned inside and out by the operating firm: YES NO

The pump came into contact with hazardous substances: YES NO

If yes: Hazardous material number according to Ordinance
on Hazardous Substances (GefStoffV): _____

or CAS registration number (Chemical Abstract Service): _____

Company/Institute: _____

Street: _____

Postcode, city: _____

Telephone: _____

Name: _____

Item: _____

Date: _____

Signature, _____

Company stamp: _____

Declaration of incorporation in accordance with the EC machinery directive

The completed and signed original declaration is supplied with the respective pump, separately to this operating manual.

EC Declaration of Incorporation

in accordance with Machinery Directive 2006/42/EC Annex II B

We,

ITT Bornemann GmbH

Industriestraße 2, 31683 Obernkirchen, Germany

Telephone: +49 (0) 5724 390-0, Fax: +49 (0) 5724 390-290

hereby declare that the following incomplete machine:

Order number:

Name:

Quantity:

Serial number:

Year of manufacture:

complies with the following essential requirements of the machinery directive (2006/42/EC): Annex I, articles 1.1.2, 1.1.3, 1.1.5, 1.3.2, 1.3.3, 1.3.4, 1.3.7 and 1.7.3.

Applied harmonised standards:

- EN 13732-1:2008
- EN 1672-2:2005+A1:2009
- EN 13951:2012
- EN 12162:2001+A1:2009
- EN ISO 12100:2010
- EN 809:1998:+A1:2009+AC:2010
- EN ISO 14159:2008

Commissioning is prohibited until such time as it has been determined that the machine into which this machine is to be incorporated corresponds with the terms of the respective Directive (2006/42/EC).

Furthermore, we hereby declare that the special technical documents for this incomplete machine have been generated per annex VII part B and we undertake to pass over a copy of these to the market surveillance authorities upon request.

Authorised for the compilation and handover of this documentation:

Obernkirchen, date:

Managing director

Head of Engineering

Declaration of conformity in accordance with the EC machinery directive

The completed and signed original declaration is supplied with the respective pump, separately to this operating manual.

EC Declaration of Conformity

in accordance with Machinery Directive 2006/42/EC Annex II A

We,

ITT Bornemann GmbH

Industriestraße 2, 31683 Obernkirchen, Germany

Telephone: +49 (0) 5724 390-0, Fax: +49 (0) 5724 390-290

hereby declare that the following machine:

Order number:

Name:

Quantity:

Serial number:

Year of manufacture:

conforms with the following EC directives, insofar as the prerequisites for commissioning stated in the engineering document, in particular in the operating instructions, are fulfilled:

- Machinery Directive (2006/42/EC)
- EMC Directive (2014/30/EU)

(The applicable directives are marked.)

Applied harmonised standards:

- EN 349: 1993+A1:2008
- EN 14120:2015
- EN 13732-1:2008
- EN 1672-2:2005+A1:2009
- EN 13951:2012
- EN 12162:2001+A1:2009
- EN ISO 12100:2010
- EN 809:1998:+A1:2009+AC:2010
- EN ISO 14159:2008

Authorised for the compilation of this documentation:

Obernkirchen, date:

Managing director

Head of Engineering



— An ITT Brand
